

XBee™ Series 2/XBee™ Series 2 PRO OEM RF Modules

XBee Series 2/Series 2 PRO PRO OEM
RF Modules
ZigBee™ Networks
RF Module Operation
RF Module Configuration
Appendices



Product Manual **v1.x.2x** - ZigBee Protocol

For OEM RF Module Part Numbers: XB24-BxIT-00x

ZigBee OEM RF Modules by Digi International

Firmware Versions:

- 1.0xx - Coordinator, Transparent Operation
- 1.1xx - Coordinator, API Operation
- 1.2xx - Router, End Device, Transparent Operation
- 1.3xx - Router, End Device, API Operation



Digi International Inc.
11001 Bren Road East
Minnetonka, MN 55343
877 912-3444 or 952 912-3444
<http://www.digi.com>

90000866_B
2007.010.031

© 2007 Digi International, Inc. All rights reserved

No part of the contents of this manual may be transmitted or reproduced in any form or by any means without the written permission of Digi International, Inc.

ZigBee® is a registered trademark of the ZigBee Alliance.

XBee™ Series 2/XBee™ Series 2 PRO is a trademark of Digi International, Inc.

Technical Support:

Phone: (801) 765-9885

Live Chat: www.digi.com

E-mail: support@digi.com

Contents

1. XBee Series 2 OEM RF Modules	4	4.3. Sleep Mode Operation	32
1.1. Key Features	4	4.3.1. End Device Operation	32
1.1.1. Worldwide Acceptance	4	4.3.2. Parent Operation	32
1.2. Specifications	5	4.4. I/O Line Configuration	32
1.3. Mechanical Drawings	6	5. Advanced Features	35
1.4. Mounting Considerations	6	5.1. Device Discovery	35
1.5. Pin Signals	7	5.2. Remote Configuration	35
1.6. Electrical Characteristics	8	5.3. Loopback Testing	35
2. RF Module Operation	9	5.3.1. AT Firmware	35
2.1. Serial Communications	9	5.3.2. API Firmware	35
2.1.1. UART Data Flow	9	5.4. Join Indicators	35
2.1.2. Serial Buffers	9	5.5. Manual Device Identification	35
2.1.3. Serial Flow Control	10	5.6. Battery Life Monitoring	36
2.1.4. Transparent Operation	12	6. XBee Series 2 Command Reference Tables	37
2.1.5. API Operation	12	7. API Operation	43
2.2. Modes of Operation	13	7.0.1. API Frame Specifications	43
2.2.1. Idle Mode	13	7.0.2. API Frames	44
2.2.2. Transmit Mode	13	8. Examples	56
2.2.3. Receive Mode	14	8.0.1. Starting an XBee Network	56
2.2.4. Command Mode	14	8.0.2. AT Command Programming Examples	57
2.2.5. Sleep Mode	15	8.0.3. API Programming Examples	57
3. ZigBee Networks	17	9. Manufacturing Support	59
3.1. ZigBee Network Formation	17	9.1. Interoperability with other EM250 Devices	59
3.1.1. Starting a ZigBee Coordinator	17	9.2. Customizing XBee Default Parameters	59
3.1.2. Joining a Router	17	9.3. XBee Series 2 Custom Bootloader	59
3.1.3. Joining an End Device	18	9.4. Programming XBee Series 2 Modules	59
3.2. ZigBee Network Communications	19	9.5. XBee EM250 Pin Mappings	59
3.2.1. ZigBee Device Addressing	19	Appendix A: Definitions	61
3.2.2. ZigBee Application-layer Addressing	19	Appendix B: Agency Certifications	63
3.2.3. Data Transmission and Routing	20	Appendix C: Migrating from the 802.15.4 Protocol	67
4. XBee Series 2 Networks	25	Appendix D: Development Guide	68
4.1. XBee Series 2 Network Formation	25	Appendix E: Additional Information	78
4.1.1. Starting an XBee Series 2 Coordinator	25		
4.1.2. Joining an XBee Series 2 Router to an existing PAN	25		
4.1.3. Joining an XBee Series 2 End Device to an Existing PAN	25		
4.1.4. Network Reset	26		
4.2. XBee Series 2 Addressing	27		
4.2.1. Device Addressing	27		
4.2.2. Application-layer Addressing	29		
4.2.3. XBee Series 2 Binding Table	29		
4.2.4. XBee Series 2 Endpoint Table	31		

1. XBee Series 2/XBee Series 2 PRO OEM RF Modules

The XBee Series 2 PRO OEM RF Modules were engineered to operate within the ZigBee protocol and support the unique needs of low-cost, low-power wireless sensor networks. The modules require minimal power and provide reliable delivery of data between remote devices.

The modules operate within the ISM 2.4 GHz frequency band.



1.1. Key Features

High Performance, Low Cost

- Indoor/Urban: up to 300' (100 m)
- Outdoor line-of-sight: up to 1 mile (1.6 km)
- Transmit Power Output: 100 mW (20 dBm) EIRP
- Receiver Sensitivity: -102 dBm

RF Data Rate: 250,000 bps

Advanced Networking & Security

Retries and Acknowledgements
DSSS (Direct Sequence Spread Spectrum)
Each direct sequence channel has over 65,000 unique network addresses available
Point-to-point, point-to-multipoint and peer-to-peer topologies supported
Self-routing, self-healing and fault-tolerant mesh networking

Low Power

XBee Series 2 PRO

- TX Current: 295 mA (@3.3 V)
- RX Current: 45 mA (@3.3 V)
- Power-down Current: < 1 μ A @ 25°C

Easy-to-Use

No configuration necessary for out-of box RF communications

AT and API Command Modes for configuring module parameters

Small form factor

Extensive command set

Free X-CTU Software
(Testing and configuration software)

Free & Unlimited Technical Support

1.1.1. Worldwide Acceptance

FCC Approval (USA) Refer to Appendix A [p50] for FCC Requirements. Systems that contain XBee Series 2/XBee Series 2 PRO RF Modules inherit Digi Certifications.

ISM (Industrial, Scientific & Medical) **2.4 GHz frequency band**

Manufactured under **ISO 9001:2000** registered standards

XBee Series 2/XBee Series 2 PRO RF Modules are optimized for use in **US, Canada, Australia, Israel and Europe** (contact MaxStream for complete list of agency approvals).



1.2. Specifications

Table 1-01. Specifications of the XBee Series 2/XBee Series 2 PRO OEM RF Module

Specification	XBee Series 2	XBee Series 2 PRO
Performance		
Indoor/Urban Range	up to 133 ft. (40 m)*	up to 300 ft. (100 m)*
Outdoor RF line-of-sight Range	up to 400 ft. (120 m)*	up to 1 mile (1.6 km)
Transmit Power Output (software selectable)	2mW (+3dBm), boost mode enabled 1.25mW (+1dBm), boost mode disabled	79mW (+19 dBm)
RF Data Rate	250,000 bps	250,000 bps
Serial Interface Data Rate (software selectable)	1200 - 230400 bps (non-standard baud rates also supported)	1200 - 230400 bps (non-standard baud rates also supported)
Receiver Sensitivity	-96 dBm, boost mode enabled -95 dBm, boost mode disabled	-102 dBm
Power Requirements		
Supply Voltage	2.1 - 3.6 V	3.0 - 3.4 V
Operating Current (Transmit, max output power)	40mA (@ 3.3 V, boost mode enabled) 35mA (@ 3.3 V, boost mode disabled)	295mA (@3.3 V)
Operating Current (Receive))	40mA (@ 3.3 V, boost mode enabled) 38mA (@ 3.3 V, boost mode disabled)	45 mA (@3.3 V)
Idle Current (Receiver off)	15mA	15mA
Power-down Current	< 1 uA @ 25°C	< 1 uA @ 25°C
General		
Operating Frequency Band	ISM 2.4 GHz	ISM 2.4 GHz
Dimensions	0.960" x 1.087" (2.438cm x 2.761cm)	0.960" x 1.297" (2.438cm x 3.294cm)
Operating Temperature	-40 to 85° C (industrial)	-40 to 85° C (industrial)
Antenna Options	Integrated Whip, Chip, RPSMA, or U.FL Connector*	Integrated Whip, Chip, RPSMA, or U.FL Connector*
Networking & Security		
Supported Network Topologies	Point-to-point, Point-to-multipoint, Peer-to-peer, and Mesh	Point-to-point, Point-to-multipoint, Peer-to-peer, and Mesh
Number of Channels (software selectable)	16 Direct Sequence Channels	14 Direct Sequence Channels
Addressing Options	PAN ID and Addresses, Cluster IDs and Endpoints (optional)	PAN ID and Addresses, Cluster IDs and Endpoints (optional)
Agency Approvals		
United States (FCC Part 15.247)	OUR-XBEE2	MCQ-XBEEPRO2
Industry Canada (IC)	4214A-XBEE2	1846A-XBEEPRO2
Europe (CE)	ETSI	ETSI

1.3. Mechanical Drawings

Figure 1-01. Mechanical drawings of the XBee Series 2/XBee Series 2 PRO OEM RF Modules (antenna options not shown)

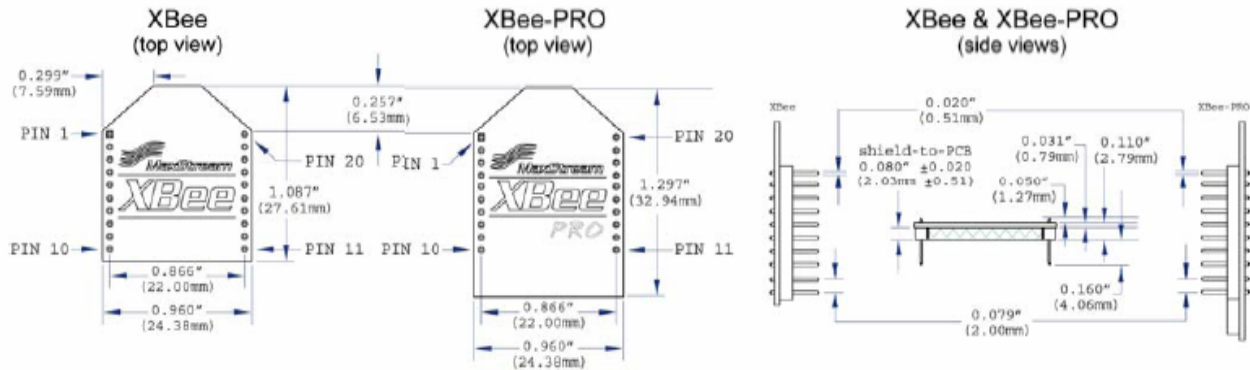

1.4. Mounting Considerations

The XBee Series 2/XBee Series 2 PRO RF Module (through-hole) was designed to mount into a receptacle (socket) and therefore does not require any soldering when mounting it to a board. The XBee Series 2 PRO Development Kits contain RS-232 and USB interface boards which use two 20-pin receptacles to receive modules.

Figure 1-02. XBee Series 2 PRO Module Mounting to an RS-232 Interface Board.

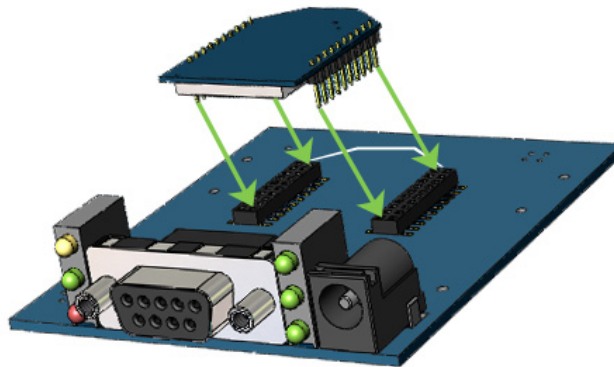

The receptacles used on Digi development boards are manufactured by Century Interconnect. Several other manufacturers provide comparable mounting solutions; however, Digi currently uses the following receptacles:

- Through-hole single-row receptacles -
Samtec P/N: MMS-110-01-L-SV (or equivalent)
- Surface-mount double-row receptacles -
Century Interconnect P/N: CPRMSL20-D-0-1 (or equivalent)
- Surface-mount single-row receptacles -
Samtec P/N: SMM-110-02-SM-S

Digi also recommends printing an outline of the module on the board to indicate the orientation the module should be mounted.

1.5. Pin Signals

Figure 1-03. XBee Series 2/XBee Series 2 PRO RF Module Pin Number
(top sides shown - shields on bottom)

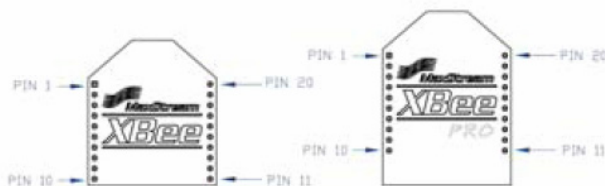

Table 1-02. Pin Assignments for the XBee Series 2 PRO Modules
(Low-asserted signals are distinguished with a horizontal line above signal name.)

Pin #	Name	Direction	Description
1	VCC	-	Power supply
2	DOUT	Output	UART Data Out
3	DIN / <u>CONFIG</u>	Input	UART Data In
4	DIO12	Either	Digital I/O 12
5	<u>RESET</u>	Input	Module Reset (reset pulse must be at least 200 ns)
6	PWM0 / RSSI / DIO10	Either	PWM Output 0 / RX Signal Strength Indicator / Digital IO
7	PWM / DIO11	Either	Digital I/O 11
8	[reserved]	-	Do not connect
9	<u>DTR</u> / SLEEP_RQ/ DIO8	Either	Pin Sleep Control Line or Digital IO 8
10	GND	-	Ground
11	DIO4	Either	Digital I/O 4
12	<u>CTS</u> / DIO7	Either	Clear-to-Send Flow Control or Digital I/O 7
13	<u>ON</u> / SLEEP / DIO9	Output	Module Status Indicator or Digital I/O 9
14	[reserved]	-	Do not connect
15	Associate / DIO5	Either	Associated Indicator, Digital I/O 5
16	<u>RTS</u> / DIO6	Either	Request-to-Send Flow Control, Digital I/O 6
17	AD3 / DIO3	Either	Analog Input 3 or Digital I/O 3
18	AD2 / DIO2	Either	Analog Input 2 or Digital I/O 2
19	AD1 / DIO1	Either	Analog Input 1 or Digital I/O 1
20	AD0 / DIO0 / ID Button	Either	Analog Input 0, Digital I/O 0, or Node Identification

Design Notes:

- Minimum connections: VCC, GND, DOUT & DIN
- Minimum connections to support serial firmware upgrades: VCC, GND, DIN, DOUT, RTS & DTR
- Signal Direction is specified with respect to the module
- Module includes a 30k Ohm resistor attached to RESET
- Several of the input pull-ups can be configured using the PR command
- Unused pins should be left disconnected

1.6. Electrical Characteristics

Table 1-03. DC Characteristics of the XBee Series 2 PRO (VCC = 3.0 - 3.4 VDC).

Symbol	Parameter	Condition	Min	Typical	Max	Units
V _{IL}	Input Low Voltage	All Digital Inputs	-	-	0.2 * VCC	V
V _{IH}	Input High Voltage	All Digital Inputs	0.8 * VCC	-	0.18 * VCC	V
V _{OL}	Output Low Voltage	I _{OL} = 2 mA, VCC >= 2.7 V	-	-	0.18 * VCC	V
V _{OH}	Output High Voltage	I _{OH} = -2 mA, VCC >= 2.7 V	0.82 * VCC	-	-	V
I _{IN}	Input Leakage Current	V _{IN} = VCC or GND, all inputs, per pin	-	-	0.5uA	uA

2. RF Module Operation

2.1. Serial Communications

The XBee Series 2 OEM RF Modules interface to a host device through a logic-level asynchronous serial port. Through its serial port, the module can communicate with any logic and voltage compatible UART; or through a level translator to any serial device (For example: Through a Digi proprietary RS-232 or USB interface board).

2.1.1. UART Data Flow

Devices that have a UART interface can connect directly to the pins of the RF module as shown in the figure below.

Figure 2-01. System Data Flow Diagram in a UART-interfaced environment
(Low-asserted signals distinguished with horizontal line over signal name.)

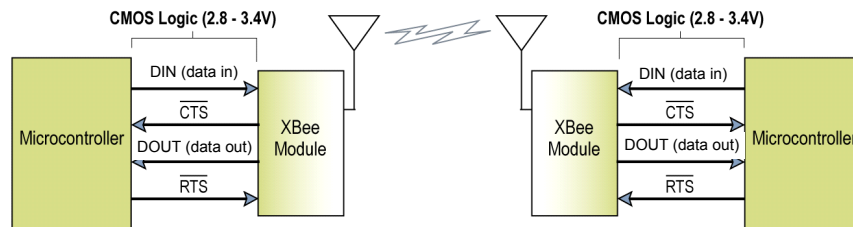

Serial Data

Data enters the module UART through the DIN (pin 3) as an asynchronous serial signal. The signal should idle high when no data is being transmitted.

Each data byte consists of a start bit (low), 8 data bits (least significant bit first) and a stop bit (high). The following figure illustrates the serial bit pattern of data passing through the module.

Figure 2-02. UART data packet 0x1F (decimal number "31") as transmitted through the RF module
Example Data Format is 8-N-1 (bits - parity - # of stop bits)

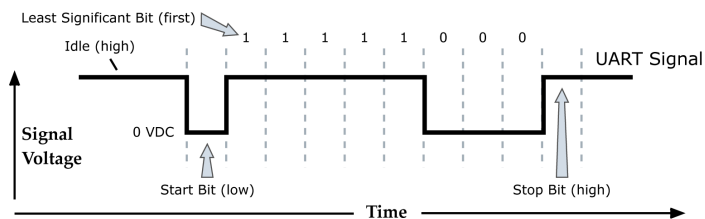

The module UART performs tasks, such as timing and parity checking, that are needed for data communications. Serial communications depend on the two UARTs to be configured with compatible settings (baud rate, parity, start bits, stop bits, data bits).

2.1.2. Serial Buffers

The XBee Series 2 modules maintain small buffers to collect received serial and RF data, which is illustrated in the figure below. The serial receive buffer collects incoming serial characters and holds them until they can be processed. The serial transmit buffer collects data that is received via the RF link that will be transmitted out the UART.

Figure 2-03. Internal Data Flow Diagram

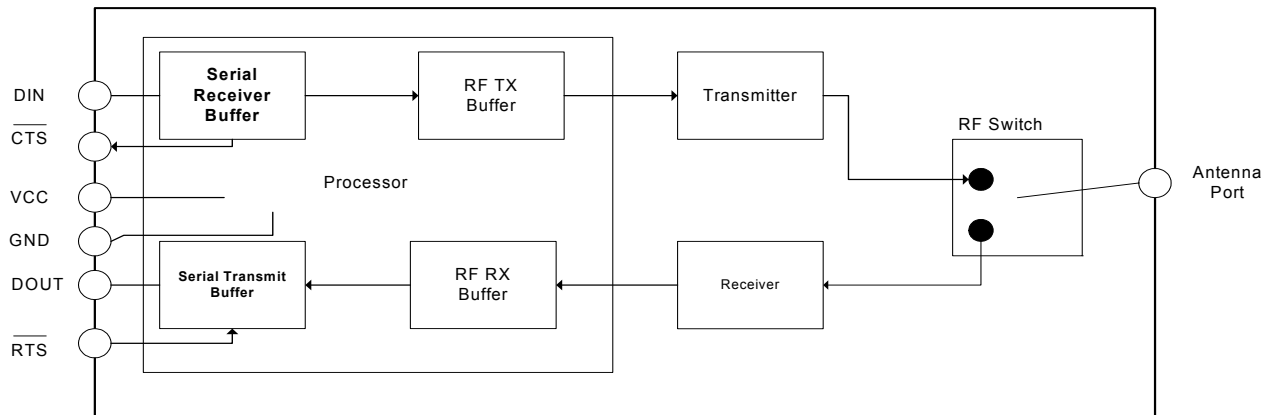

Serial Receive Buffer

When serial data enters the RF module through the DIN Pin (pin 3), the data is stored in the serial receive buffer until it can be processed. Under certain conditions, the module may not be able to process data in the serial receive buffer immediately. If large amounts of serial data are sent to the module, CTS flow control may be required to avoid overflowing the serial receive buffer.

Cases in which the serial receive buffer may become full and possibly overflow:

1. If the module is receiving a continuous stream of RF data, the data in the serial receive buffer will not be transmitted until the module is no longer receiving RF data.
2. If the module is transmitting an RF data packet, the module may need to discover the destination address or establish a route to the destination. After transmitting the data, the module may need to retransmit the data if an acknowledgment is not received, or if the transmission is a broadcast. These issues could delay the processing of data in the serial receive buffer.

Serial Transmit Buffer

When RF data is received, the data is moved into the serial transmit buffer and is sent out the serial port. If the serial transmit buffer becomes full enough such that all data in a received RF packet won't fit in the serial transmit buffer, the entire RF data packet is dropped.

Cases in which the serial transmit buffer may become full resulting in dropped RF packets

1. If the RF data rate is set higher than the interface data rate of the module, the module could receive data faster than it can send the data to the host.
2. If the host does not allow the module to transmit data out from the serial transmit buffer because of being held off by hardware flow control.

2.1.3. Serial Flow Control

The $\overline{\text{RTS}}$ and $\overline{\text{CTS}}$ module pins can be used to provide $\overline{\text{RTS}}$ and/or $\overline{\text{CTS}}$ flow control. $\overline{\text{CTS}}$ flow control provides an indication to the host to stop sending serial data to the module. $\overline{\text{RTS}}$ flow control allows the host to signal the module to not send data in the serial transmit buffer out the uart. $\overline{\text{RTS}}$ and $\overline{\text{CTS}}$ flow control are enabled using the D6 and D7 commands.

$\overline{\text{CTS}}$ Flow Control

If $\overline{\text{CTS}}$ flow control is enabled (D7 command), when the serial receive buffer is 17 bytes away from being full, the module de-asserts $\overline{\text{CTS}}$ (sets it high) to signal to the host device to stop sending serial data. $\overline{\text{CTS}}$ is re-asserted after the serial receive buffer has 34 bytes of space.

RTS Flow Control

If flow $\overline{\text{RTS}}$ control is enabled (D6 command), data in the serial transmit buffer will not be sent out the DOUT pin as long as $\overline{\text{RTS}}$ is de-asserted (set high). The host device should not de-assert $\overline{\text{RTS}}$ for long periods of time to avoid filling the serial transmit buffer. If an RF data packet is received, and the serial transmit buffer does not have enough space for all of the data bytes, the entire RF data packet will be discarded.

RF modules that contain the following firmware versions will support Transparent Mode:
1.0xx (coordinator) and 1.2xx (router/end device).

When operating in Transparent Mode, the modules act as a serial line replacement. All UART data received through the DIN pin is queued up for RF transmission. When RF data is received, the data is sent out the DOUT pin. The module configuration parameters are configured using the AT command mode interface. (See RF Module Operation --> Command Mode.)

When RF data is received by a module, the data is sent out the DOUT pin.

Serial-to-RF Packetization

Data is buffered in the serial receive buffer until one of the following causes the data to be packetized and transmitted:

1. No serial characters are received for the amount of time determined by the RO (Packetization Timeout) parameter. If RO = 0, packetization begins when a character is received.
2. Maximum number of characters that will fit (72) in an RF packet is received.
3. The Command Mode Sequence (GT + CC + GT) is received. Any character buffered in the serial receive buffer before the sequence is transmitted.

2.1.4. API Operation

API (Application Programming Interface) Operation is an alternative to the default Transparent Operation. The frame-based API extends the level to which a host application can interact with the networking capabilities of the module. RF modules that contain the following firmware versions will support API operation: 1.1xx (coordinator) and 1.3xx (router/end device).

When in API mode, all data entering and leaving the module is contained in frames that define operations or events within the module.

Transmit Data Frames (received through the DIN pin (pin 3)) include:

- RF Transmit Data Frame
- Command Frame (equivalent to AT commands)

Receive Data Frames (sent out the DOUT pin (pin 2)) include:

- RF-received data frame
- Command response
- Event notifications such as reset, associate, disassociate, etc.

The API provides alternative means of configuring modules and routing data at the host application layer. A host application can send data frames to the module that contain address and payload information instead of using command mode to modify addresses. The module will send data frames to the application containing status packets; as well as source, and payload information from received data packets.

The API operation option facilitates many operations such as the examples cited below:

- > Transmitting data to multiple destinations without entering Command Mode
- > Receive success/failure status of each transmitted RF packet
- > Identify the source address of each received packet

To implement API operations, refer to the API Operation chapter 6.

2.2. Modes of Operation

2.2.1. Idle Mode

When not receiving or transmitting data, the RF module is in Idle Mode. During Idle Mode, the RF module is also checking for valid RF data. The module shifts into the other modes of operation under the following conditions:

- Transmit Mode (Serial data in the serial receive buffer is ready to be packetized)
- Receive Mode (Valid RF data is received through the antenna)
- Sleep Mode (End Devices only)
- Command Mode (Command Mode Sequence is issued)

2.2.2. Transmit Mode

When serial data is received and is ready for packetization, the RF module will exit Idle Mode and attempt to transmit the data. The destination address determines which node(s) will receive the data.

Prior to transmitting the data, the module ensures that a 16-bit network address and route to the destination node have been established.

If the 16-bit network address is not known, network address discovery will take place. If a route is not known, route discovery will take place for the purpose of establishing a route to the destination node. If a module with a matching network address is not discovered, the packet is discarded. The data will be transmitted once a route is established. If route discovery fails to establish a route, the packet will be discarded.

Figure 2-04. Transmit Mode Sequence

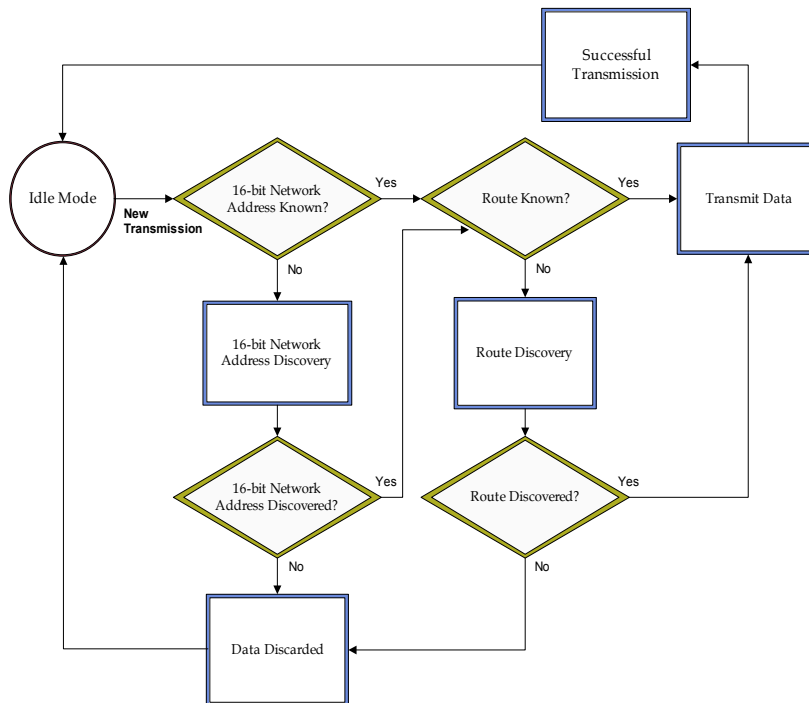

When data is transmitted from one node to another, a network-level acknowledgement is transmitted back across the established route to the source node. This acknowledgement packet indicates to the source node that the data packet was received by the destination node. If a network acknowledgement is not received, the source node will re-transmit the data. See Data Transmission and Routing in chapter 3 for more information.

2.2.3. Receive Mode

If a valid RF packet is received, the data is transferred to the serial transmit buffer

2.2.4. Command Mode

To modify or read RF Module parameters, the module must first enter into Command Mode - a state in which incoming serial characters are interpreted as commands. Refer to the API Mode section for an alternate means of configuring modules.

AT Command Mode

To Enter AT Command Mode:

Send the 3-character command sequence “+++” and observe guard times before and after the command characters. [Refer to the “Default AT Command Mode Sequence” below.]

Default AT Command Mode Sequence (for transition to Command Mode):

- No characters sent for one second [GT (Guard Times) parameter = 0x3E8]
- Input three plus characters (“+++”) within one second [CC (Command Sequence Character) parameter = 0x2B.]
- No characters sent for one second [GT (Guard Times) parameter = 0x3E8]

All of the parameter values in the sequence can be modified to reflect user preferences.

NOTE: Failure to enter AT Command Mode is most commonly due to baud rate mismatch. Ensure the ‘Baud’ setting on the “PC Settings” tab matches the interface data rate of the RF module. By default, the BD parameter = 3 (9600 bps).

To Send AT Commands:

Send AT commands and parameters using the syntax shown below.

Figure 2-05. Syntax for sending AT Commands

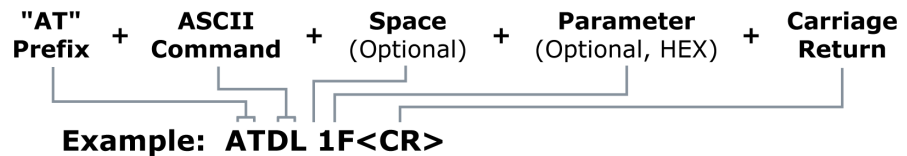

To read a parameter value stored in the RF module’s register, omit the parameter field.

The preceding example would change the RF module Destination Address (Low) to “0x1F”. To store the new value to non-volatile (long term) memory, subsequently send the WR (Write) command.

For modified parameter values to persist in the module’s registry after a reset, changes must be saved to non-volatile memory using the WR (Write) Command. Otherwise, parameters are restored to previously saved values after the module is reset.

System Response. When a command is sent to the module, the module will parse and execute the command. Upon successful execution of a command, the module returns an “OK” message. If execution of a command results in an error, the module returns an “ERROR” message.

To Exit AT Command Mode:

1. Send the ATCN (Exit Command Mode) command (followed by a carriage return).
[OR]
2. If no valid AT Commands are received within the time specified by CT (Command Mode Timeout) Command, the RF module automatically returns to Idle Mode.

For an example of programming the RF module using AT Commands and descriptions of each configurable parameter, refer to the “Examples” and “XBee Series 2 Command Reference Tables” chapters.

2.2.5. Sleep Mode

Sleep modes allow the RF module to enter states of low-power consumption when not in use. To enter Sleep Mode, one of the following conditions must be met (in addition to the module having a non-zero SM parameter value):

- Sleep_RQ (pin 9) is asserted
- The module is idle (no data is transmitted or received) for the time defined by the ST (Time before Sleep) parameter.

Table 2-01. Sleep Mode Configurations (Router / End Device Firmware Only)

Sleep Mode Setting	Transition into Sleep Mode	Transition out of Sleep Mode (wake)	Characteristics	Related Commands	Power Consumption
SM=1	Assert (high) Sleep_RQ (pin 9)	De-assert (0V) Sleep_RQ (pin 9)	Pin/Host controlled	SM	< 1uA
SM=4	Automatic transition to sleep mode as defined by the ST parameter	Transition occurs after the cyclic sleep time interval elapses. The time interval is defined by the SP (Cyclic Sleep Period) parameter.	RF module wakes after a pre-determined time interval to detect if RF data is present.	SM, ST, SP, SN	< 1uA

The SM command is central to setting Sleep Mode configurations. By default, sleep modes are disabled (SM=0) and the module remains in Idle/Receive Mode. When in this state, the module is constantly ready to respond to serial or RF activity.

ZigBee Protocol: Sleep Modes

In the ZigBee protocol, sleep modes are only supported on end devices. See section 4.3, "Sleep Mode Operation" for more information.

Pin/Host Controlled Sleep

Pin sleep puts the module to sleep and wakes it from sleep according to the state of Sleep_RQ (pin 9). When Sleep_RQ is asserted (high), the module will finish any transmit or receive operations, and then enter a low power state. The module will not respond to either serial or RF activity while in sleep.

To wake a module operating in pin sleep, de-assert Sleep_RQ (pin 9). The module will wake when Sleep_RQ is de-asserted and is ready to transmit or receive when the CTS line is low. When the module wakes from pin sleep, it sends a transmission to its parent router or coordinator (called a poll request) to see if it has buffered any data packets for the end device. The module will continue to poll its parent for data while it remains awake. If the parent receives an RF data packet destined for one or more of its end device children, it will transmit the packet to the end device upon receipt of a poll request. See section 4.3, "Sleep Mode Operation" for more information.

Cyclic Sleep

Cyclic sleep allows modules to wake periodically to check for RF data and sleep when idle. When the SM parameter is set to 4, the module is configured to sleep for the time specified by the SP parameter. After the SP time expires, the module will wake and check for RF or serial data. To check for RF data, the module sends a transmission to its parent router or coordinator (called a poll request) to see if its parent has any buffered data packets for the end device. If the parent has data for the module, the module will remain awake to receive the data. Otherwise, the module will return to sleep. (See section 4.3, "Sleep Mode Operation" for more information.)

If serial or RF data is received, the module will start the ST timer and remain awake until the timer expires. While the module is awake, it will continue to send poll request messages to its parent to check for additional data. The ST timer will be restarted anytime serial or RF activity occurs. The module will resume sleep when the ST timer expires.

When the module wakes from sleep, it asserts On/Sleep (pin 13) to provide a wake indicator to a host device. If a host device wishes to sleep longer than SP time or to wake only when RF data arrives, the SN command can be used to prevent On/Sleep from asserting for a multiple of SP time. For example, if SP = 20 seconds, and SN = 5, the On/Sleep pin will remain de-asserted (low) for up to 100 seconds.

If CTS flow control is enabled, CTS (pin 12) is asserted (0V) when the module wakes and de-asserted (high) when the module sleeps, allowing for communication initiated by the host if desired.

3. ZigBee Networks

3.1. ZigBee Network Formation

A ZigBee Personal Area Network (PAN) consists of one coordinator and one or more routers and/or end devices. A ZigBee Personal Area Network (PAN) is created when a coordinator selects a channel and PAN ID to start on. Once the coordinator has started a PAN, it can allow router and end device nodes to join the PAN.

When a router or end device joins a PAN, it receives a 16-bit network address and can transmit data to or receive data from other devices in the PAN. Routers and the coordinator can allow other devices to join the PAN, and can assist in sending data through the network to ensure data is routed correctly to the intended recipient device. When a router or coordinator allows an end device to join the PAN, the end device that joined becomes a child of the router or coordinator that allowed the join.

End devices, however can transmit or receive data but cannot route data from one node to another, nor can they allow devices to join the PAN. End devices must always communicate directly to the parent they joined to. The parent router or coordinator can route data on behalf of an end device child to ensure it reaches the correct destination. End devices are intended to be battery powered and can support low power modes.

Figure 3-01. Node Types / Sample of a Basic ZigBee Network Topology

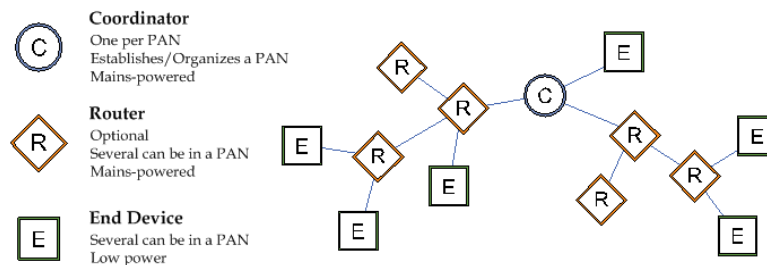

The network address of the PAN coordinator is always 0. When a router joins a PAN, it can also allow other routers and end devices to join to it. Joining establishes a parent/child relationship between two nodes. The node that allowed the join is the parent, and the node that joined is the child. The parent/child relationship is not necessary for routing data.

3.1.1. Starting a ZigBee Coordinator

When a coordinator first comes up, it performs an energy scan on multiple channels (frequencies) to select an unused channel to start the PAN. After removing channels with high detected energy levels, the coordinator issues an 802.15.4 beacon request command on the remaining, low energy level channels. Nearby routers or coordinators that have already joined a PAN respond to the beacon request frame with a small beacon transmission indicating the PAN identifier (PAN ID) that they are operating on, and whether or not they are allowing joining. The coordinator will attempt to start on an unused PAN ID and channel. After starting, the coordinator may allow other devices to join its PAN.

3.1.2. Joining a Router

When a router first comes up, it must locate and join a ZigBee PAN. To do this, it issues an 802.15.4 beacon request command on multiple channels to locate nearby PANs. Nearby routers and coordinators that have already joined a PAN respond to the beacon request frame with a small beacon transmission, indicating which channel and PAN ID they are operating on. The router listens on each channel for these beacon frames. If a valid PAN is found from one of the received beacons, the router issues a join request to the device that sent the beacon. If joining succeeds, the router will then receive a join confirmation from the device, indicating the join was successful.

Once the router joins the PAN, it can communicate with other devices on the PAN and allow new devices to join to it.

3.1.3. Joining an End Device

When an end device first comes up, it must also locate and join a PAN. End devices follow the same process as a router to join a PAN. Once the end device has successfully joined a PAN, it can communicate with other devices on the PAN. However, since end devices cannot route data, they must always communicate directly with their parent and allow the parent to route data in its behalf.

Figure 3-02. Demonstration of Beacon Request and Beacon transmissions that take place during joining.

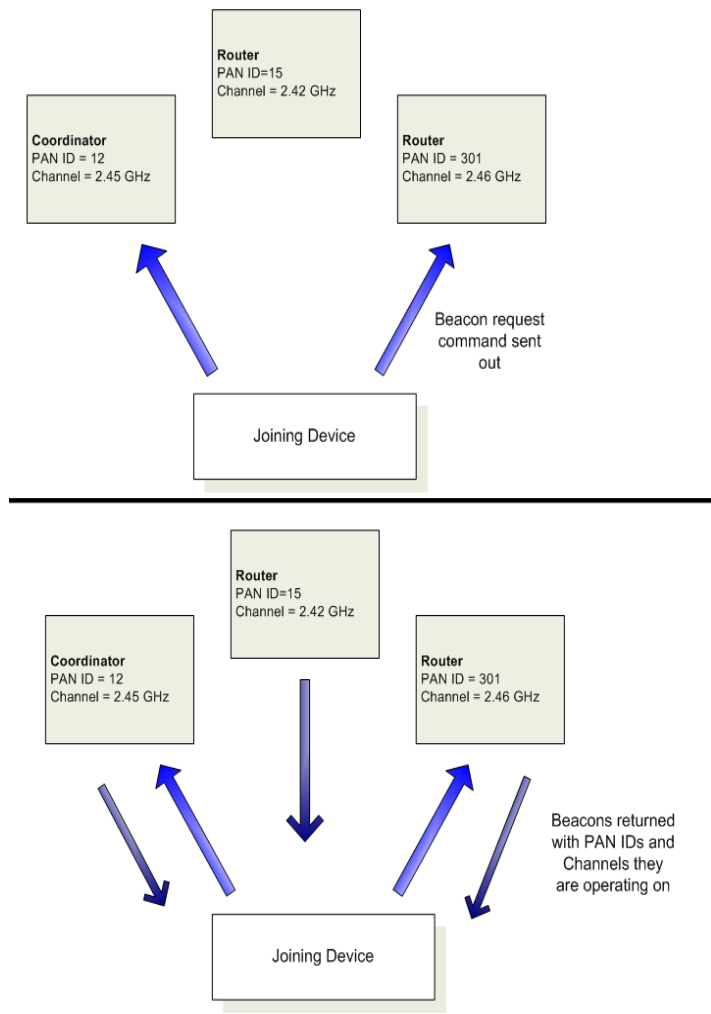

3.2. ZigBee Network Communications

ZigBee supports device addressing and application layer addressing. Device addressing specifies the destination address of the device a packet is destined to. Application layer addressing indicates a particular application recipient, known as a ZigBee endpoint, along with a message type field called a Cluster ID.

3.2.1. ZigBee Device Addressing

The 802.15.4 protocol upon which the ZigBee protocol is built specifies two address types:

- 16-bit network addresses
- 64-bit Addresses

16-bit Network Addresses

A 16-bit network address is assigned to a node when the node joins a network. The network address is unique to each node in the network. However, network addresses are not static - it can change.

The following two conditions will cause a node to receive a new network address:

1. If an end device cannot communicate with its parent it may need to leave the network and rejoin to find a new parent.
2. If the device type changes from router to end device, or vice-versa, the device will leave the network and rejoin as the new device type.

ZigBee requires that data be sent to the 16-bit network address of the destination device. This requires that the 16-bit address be discovered before transmitting data. See 3.2.3 Network Address Discovery for more information.

64-bit Addresses

Each node contains a unique 64-bit address. The 64-bit address uniquely identifies a node and is permanent.

3.2.2. ZigBee Application-layer Addressing

The ZigBee application layers define endpoints and cluster identifiers (cluster IDs) that are used to address individual services or applications on a device. An endpoint is a distinct task or application that runs on a ZigBee device, similar to a TCP port. Each ZigBee device may support one or more endpoints. Cluster IDs define a particular function or action on a device. Cluster IDs in the ZigBee home controls lighting profile, for example, would include actions such as "TurnLightOn", "TurnLightOff", "DimLight", etc.

Suppose a single radio controls a light dimmer and one or more light switches. The dimmer and switches could be assigned to different endpoint values. To send a message to the dimmer, a remote radio would transmit a message to the dimmer endpoint on the radio. In this example, the radio might support cluster IDs to "TurnLightOn", "TurnLightOff", or "DimLight". Thus, for radio A to turn off a light on radio B, radio A would send a transmission to the light switch endpoint on radio B, using cluster ID "TurnLightOff". This is shown in the figure below.

Figure 3-03. ZigBee Layer-Addressing Example

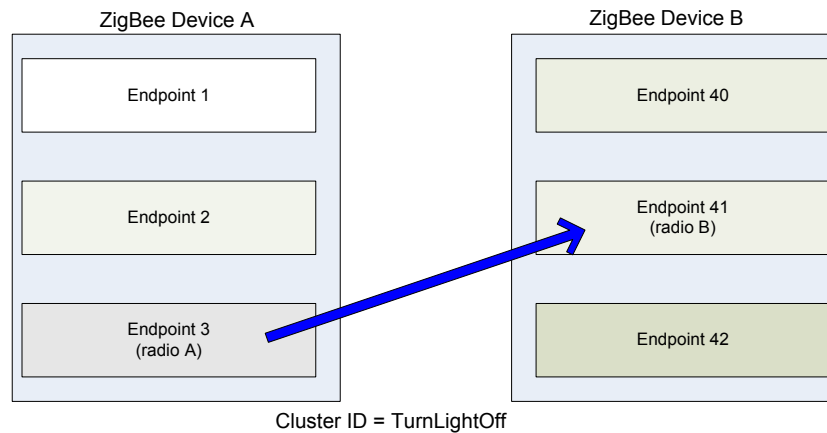

3.2.3. Data Transmission and Routing

All data packets are addressed using both device and application layer addressing fields. Data can be sent as a broadcast, multicast, or unicast transmission.

Broadcast Transmissions

Broadcast transmissions within the ZigBee protocol are intended to be propagated throughout the entire network such that all nodes receive the transmission. To accomplish this, all devices that receive a broadcast transmission will retransmit the packet 3 times.

Figure 3-04. Broadcast Data Transmission

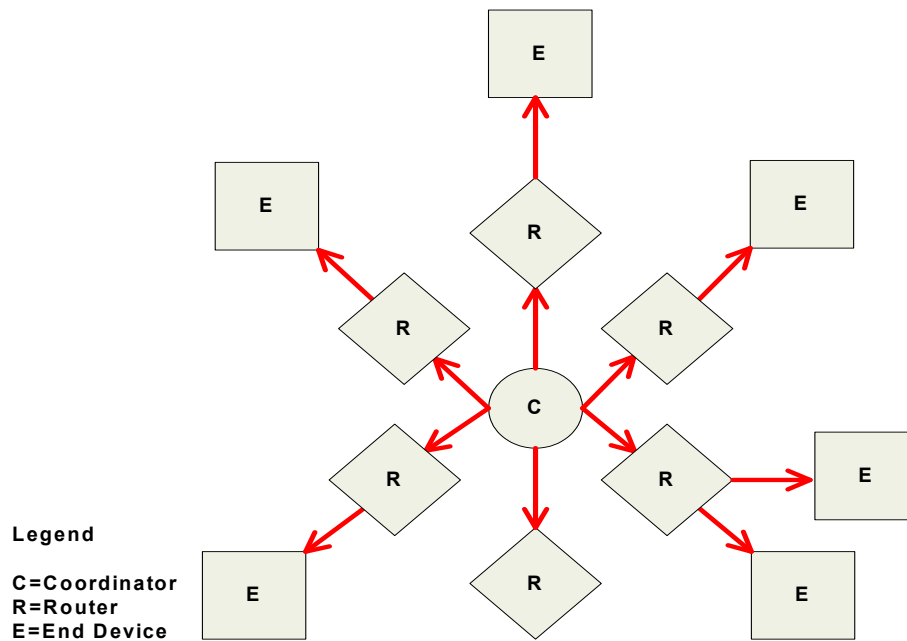

Each node that transmits the broadcast will also create an entry in a local broadcast transmission table. This entry is used to keep track of each received Zig broadcast packet to ensure the packets are

not endlessly transmitted. Each entry persists for 8 seconds. The broadcast transmission table holds 8 entries.

For each broadcast transmission, the ZigBee stack must reserve buffer space for a copy of the data packet. This copy is used to retransmit the packet as needed. Large broadcast packets will require more buffer space.

Since broadcast transmissions are retransmitted by each device in the network, broadcast messages should be used sparingly.

Multicast Transmissions

Multicast transmissions operate similar to broadcast transmissions. Data packets are broadcast throughout the network in a similar fashion. However, only devices that are part of the multicast group will receive the data packets.

Unicast Transmissions

Unicast ZigBee transmissions are always addressed to the 16-bit address of the destination device. However, only the 64-bit address of a device is permanent; the 16-bit address can change. Therefore, ZigBee devices may employ network address discovery to identify the current 16-bit address that corresponds to a known 64-bit address, and route discovery to establish a route.

Network Address Discovery

Data transmissions are always sent to the 16-bit network address of the destination device. However, since the 64-bit address is unique to each device and is generally known, ZigBee devices must discover the network address that was assigned to a particular device when it joined the PAN before they can transmit data.

To do this, the device initiating a transmission sends a broadcast network address discovery transmission throughout the network. This packet contains the 64-bit address of the device the initiator needs to send data to. Devices that receive this broadcast transmission check to see if their 64-bit address matches the 64-bit address contained in the broadcast transmission. If the addresses match, the device sends a response packet back to the initiator, providing the network address of the device with the matching 64-bit address. When this response is received, the initiator can then transmit data.

Route Discovery

ZigBee employs mesh routing to establish a route between the source device and the destination. Mesh routing allows data packets to traverse multiple nodes (hops) in a network to route data from a source to a destination. Routers and coordinators can participate in establishing routes between source and destination devices using a process called route discovery. The Route discovery process is based on the AODV (Ad-hoc On-demand Distance Vector routing) protocol.

Figure 3-05. Sample Transmission Through a Mesh Network"

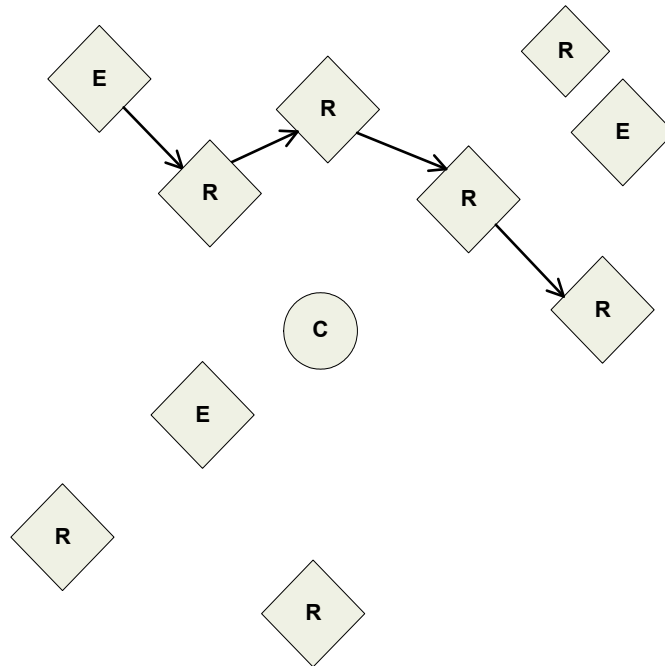

AODV (Ad-hoc On-demand Distance Vector) Routing Algorithm

Routing under the AODV protocol is accomplished using tables in each node that store the next hop (intermediary node between source and destination nodes) for a destination node. If a next hop is not known, route discovery must take place in order to find a path. Since only a limited number of routes can be stored on a Router, route discovery will take place more often on a large network with communication between many different nodes.

Table 3-01.

Node	Destination Address	Next Hop Address
R3	Router 6	Coordinator
C	Router 6	Router 5
R5	Router 6	Router 6

When a source node must discover a route to a destination node, it sends a broadcast route request command. The route request command contains the source network address, the destination network address and a path cost field (a metric for measuring route quality). As the route request command is propagated through the network (refer to the Broadcast Transmission), each node that re-broadcasts the message updates the path cost field and creates a temporary entry in its route discovery table.

Figure 3-06. Sample Route Request (Broadcast) Transmission Where R3 is Trying to Discover a Route to R6t

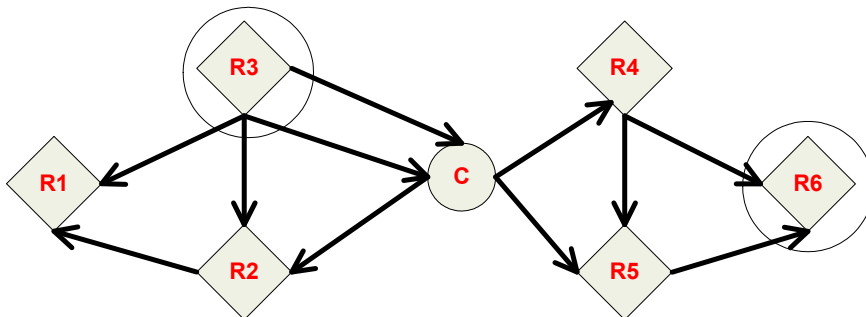

When the destination node receives a route request, it compares the 'path cost' field against previously received route request commands. If the path cost stored in the route request is better than any previously received, the destination node will transmit a route reply packet to the node that originated the route request. Intermediate nodes receive and forward the route reply packet to the source node (the node that originated route request).

Figure 3-07. Route Reply Sample Route Reply (Unicast) Where R6 Sends a Route Reply to R3.

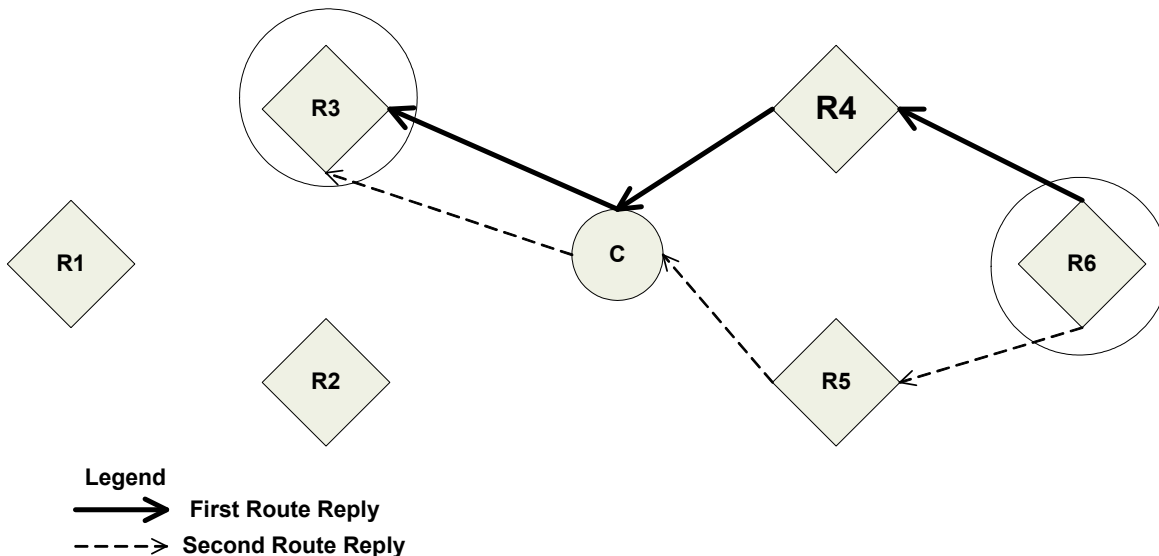

Note: R6 could send multiple replies if it identifies a better route.

Retries and Acknowledgments

ZigBee includes acknowledgment packets at both the Mac and Application Support (APS) layers. When data is transmitted to remote device, it may traverse multiple hops to reach the destination. As data is transmitted from one node to its neighbor, an acknowledgment packet (Ack) is transmitted in the opposite direction to indicate that the transmission was successfully received. If the Ack is not received, the transmitting device will retransmit the data, up to 4 times. This Ack is called the Mac layer acknowledgment.

In addition, the device that originated the transmission expects to receive an acknowledgment packet (Ack) from the destination device. This Ack will traverse the same path that the data traversed, but in the opposite direction. If the originator fails to receive this Ack, it will retransmit

the data, up to 2 times until an Ack is received. This Ack is called the ZigBee APS layer acknowledgment.

Refer to the ZigBee specification for more details.

Figure 3-08. Unicast Data Transmission

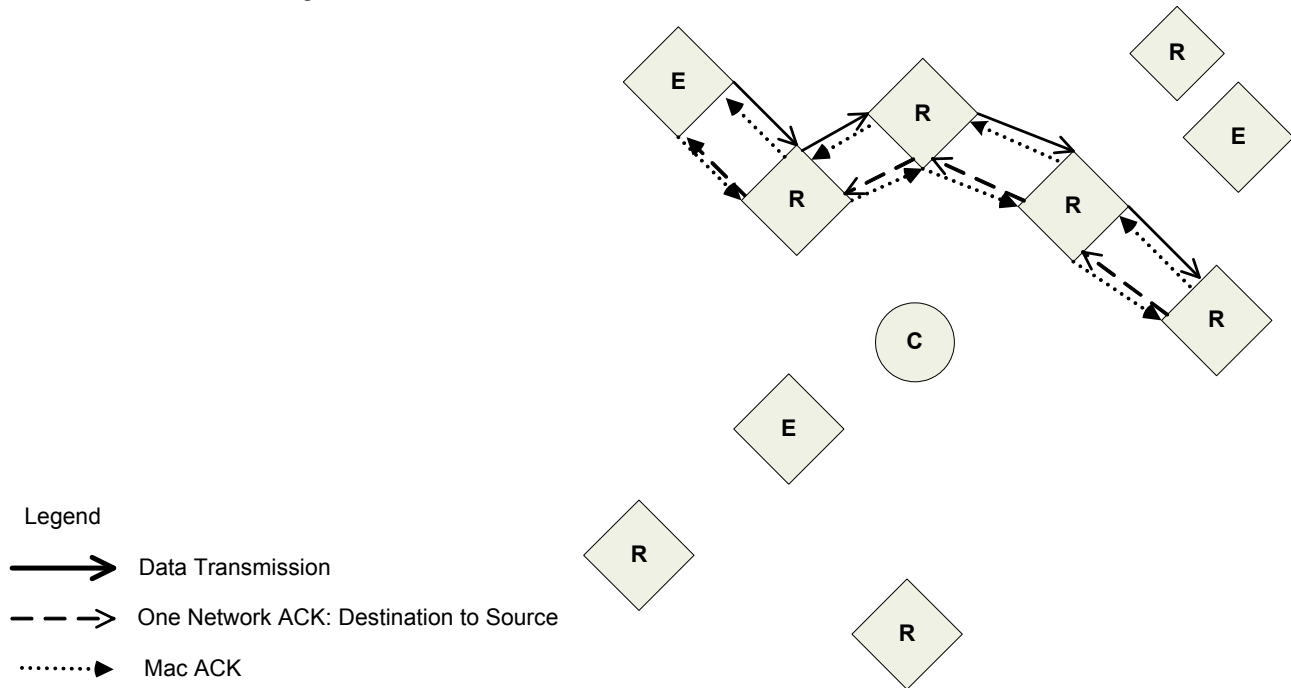

4. XBee Series 2 Networks

4.1. XBee Series 2 Network Formation

To create a ZigBee network, a coordinator must be started on a channel and PAN ID. Once the coordinator has started, routers and end device can join the network. Routers and coordinator devices can support up to 8 end device children each. Network formation is governed by the SC (Scan Channels), ID (PAN ID), SD (Scan Duration), and NJ (Node Join Time) commands. The SC and ID settings should be written using the WR command to preserve network formation or joining information."

4.1.1. Starting an XBee Series 2 Coordinator

In order to form a network, a coordinator must select an unused operating channel and PAN ID on behalf of its network. To do this, the coordinator first performs an energy scan on all channels specified by its SC (Scan Channels) parameter. The scan time on each channel is determined by the SD (Scan Duration) parameter. Once the energy scan is completed, the coordinator sends a beacon request on each of the SC channels and listens for any beacons. The information from the energy scan and the beacon scan (active scan) is used to select an unused channel and PAN ID. If the ID (PAN ID) parameter is set to 0xFFFF, the coordinator will select a random PAN ID. Otherwise, the coordinator will start on the PAN ID specified by its ID parameter.

After the coordinator has started, it will allow nodes to join to it for a time based on its NJ (Node Join Time) parameter. If the Associated LED function is enabled (D5 (DIO5 Configuration) command), the Associate pin (pin 15) will toggle its output state 1x per second after the coordinator started. At this point, the operating channel and PAN ID can be read using the CH (Operating Channel) and ID (PAN ID) commands. The 16-bit address of the coordinator is always 0. If API is enabled (AP parameter > 0): The API modem status "coordinator Started" frame is sent out the UART. The AI (Association Indication) command can be used at any point during the coordinator startup routine to determine the status of the startup operation.

4.1.2. Joining an XBee Series 2 Router to an existing PAN

Before a router can participate in a ZigBee network, the router must locate a coordinator or another router that has already joined a PAN, and attempt to join to it. To do this, it sends a beacon request frame on each of the SC channels and listens for beacon frames. The scan duration on each channel is determined by the SD parameter. The joining router will evaluate the received beacons to find a coordinator or router that is allowing joins on a valid PAN ID, and attempt to join to that device. If ID = 0xFFFF, the router will attempt to join to a device on any PAN ID. Otherwise, the router will only attempt joining with a device that operates on the PAN ID specified by the ID parameter. If a valid router/ coordinator is found, the router will attempt to join to that node. If the join succeeds, the Router has successfully started.

After the Router has started, it will allow nodes to join to it for a time based on the NJ (Node Join Time) parameter. If the Associated LED function is enabled (D5 (DIO5 Configuration) command) the Associate pin (pin 15) will toggle its output state 2x per second after the router has joined. At this point, the operating channel and PAN ID can be read using the CH (Operating Channel) and ID (PAN ID) commands. The 16-bit network address of the router can be read using the MY (16-bit Source Address) command. If API is enabled (AP parameter > 0): The API modem status "Joined" is sent out the UART. If the JN command is enabled, the router will send a node identification packet to the coordinator. The AI (Association Indication) command can be used at any point during the router join routine to know the status of the startup operation.

4.1.3. Joining an XBee Series 2 End Device to an Existing PAN

Joining an end device to a PAN is similar to joining a router. Once the end device joins a PAN, however, the end device cannot allow other devices to join to it. If the Associate LED function is enabled (D5 (DIO5 Configuration) command), the Associate pin (pin 15) will toggle its output

state 2x per second after the end device has joined. At this point, the operating channel and PAN ID can be read using the CH (Operating Channel) and ID (PAN ID) commands. The 16-bit network address of the end device can be read using the MY (16-bit Source Address) command. If API is enabled (AP parameter > 0), the API modem status "Joined" is sent out the UART. If the JN command is enabled, the router will send a node identification packet to the coordinator. The AI (Association Indication) command can be used at any point during the router join routine to know the status of the startup operation.

4.1.4. Network Reset

Once a coordinator has started, or a router or end device has joined the network, the device will continue operating on that channel and PAN ID unless one of the following occurs:

1. The ID parameter changes.
2. The SC parameter changes, such that the current operating channel is not included in the new SC parameter
3. The NR command is issued with either 0 or 1 as a parameter

If any of the above occurs on a coordinator, the coordinator will attempt to restart on a channel and PAN ID based on the new saved ID and SC commands. On a router or end device, the above conditions will cause the device to leave the network (if previously joined) and attempt to join a new PAN using the saved ID and SC parameters.

4.2. XBee Series 2 Addressing

XBee modules support both ZigBee device addressing and application-layer addressing. Device addressing provides a simple means of sending data from one device to another by hiding the application layer addressing information (ZigBee endpoints and cluster IDs). If a device will support multiple endpoints or cluster IDs, application addressing can be used to include endpoint and cluster ID information in the transmission.

Device addressing supports transmissions to:

- a destination 64-bit address
- a destination NI-string
- the ZigBee PAN coordinator
- all devices on the PAN (broadcast)
- all devices on a multicast group.

Application-layer addressing supports transmissions to:

- all of the above device addressing destinations
- specific endpoints on a destination device
- specific cluster IDs on a destination device.

4.2.1. Device Addressing

All XBee Series 2 modules can be identified by their unique 64-bit addresses or a user-configurable ASCII string identifier. The 64-bit address of a module can be read using the SH and SL commands. The ASCII string identifier is configured using the NI command. To transmit using device addressing, only the destination address must be configured. The destination address can be specified using either the destination device's 64-bit address or its NI-string. The XBee modules also support coordinator and broadcast addressing modes. Device addressing in the AT firmware is configured using the DL, DH, or DN commands. In the API firmware, the ZigBee Transmit Request API frame (0x10) can be used to specify destination addresses.

64-Bit Addressing (Transparent)

To address a node by its 64-bit address, the destination address must be set to match the 64-bit address of the remote. In the AT firmware, the DH and DL commands set the destination 64-bit address. In the API firmware, the destination 64-bit address is set in the ZigBee Transmit Request frame.

To send a packet to an RF module using its 64-bit Address (Transparent Mode)

Set the DH (Destination Address High) and DL (Destination Address Low) parameters of the source node to match the 64-bit Address (SH (Serial Number High) and SL (Serial Number Low) parameters) of the destination node

Since the ZigBee protocol relies on the 16-bit network address for routing, the 64-bit address must be converted into a 16-bit network address prior to transmitting data. If a module does not know the 16-bit network address for a given 64-bit address, it will transmit a broadcast network address Discovery command. The module with a matching 64-bit address will transmit its 16-bit network address back. Once the network address is discovered, the data will be transmitted.

The modules maintain a table that can store up to seven 64-bit addresses and their corresponding 16-bit network addresses.

64-bit Addressing (API)

To send a packet to an RF module using its 64-bit Address (API Mode)

Use the ZigBee Transmit Request API frame to set 64-bit destination address of the source node to match the 64-bit Address (SH (Serial Number High) and SL (Serial Number Low) parameters) of the destination node.

If the 16-bit address of the destination node is not known, set 16-bit destination network address to 0xFFFFE (refer to the 'API Addressing section below).

To send an API transmission to a Coordinator using its 16-bit network address:)

Set the 64-bit Destination Address field to all 0's.

API Mode provides the ability to store and maintain 16-bit network address tables on an external processor. The 16-bit network address information is provided to the application through the following:

- The ZigBee Transmit Status Frame (contains the current 16-bit network address of the remote)
- The ND and DN commands (return 64-bit and 16-bit network addresses of remote nodes)

With this information, a table can be built in an application that maps a 64-bit Address to the corresponding 16-bit network address.

The ZigBee Transmit Request API frame specifies the 64-bit Address and the network address (if known) that the packet should be sent to. By supplying both addresses, the module will forego network address Discovery and immediately attempt to route the data packet to the remote. If the network address of a particular remote changes, network address and route discovery will take place to establish a new route to the correct node. Upon successful packet delivery, the TX Status Frame will indicate the correct network address of the remote.

Table 4-02. Sample table mapping 64-bit Addresses to 16-bit Network Addresses

Index	64-bit Address	16-bit Network Address
0	0013 4000 4000 0001	1234
1	0013 4000 4000 0002	5678
2	0013 4000 4000 01A0	A479
3	0013 4000 4000 0220	1F70

NI-String Addressing

The NI string can alternatively be used to address a remote module.

To send a packet to an RF module using its NI-string (Transparent Mode)

Issue the DN (Destination Node) command using the NI (Node Identifier)-string of the destination node as the parameter.

To send a packet to an RF module using its NI-string (API Mode)

Issue the DN command as stated above using the AT Command API frame.

When the DN command is issued, a broadcast transmission is sent across the network to discover the module that has a matching NI (Node Identifier) parameter. If a module is discovered with a matching NI-string, the DH and DL parameters will be configured to address the destination node and the command will return both the 64-bit Address and the 16-bit network address of the discovered node. Data can be transmitted after the DN (Destination Node) command finishes.

the AO command. See "API Frames" section for details.

Coordinator Addressing

A Coordinator can be addressed using its 64-bit address or NI string as described in the "NI-String Addressing" section. Alternatively, since the ZigBee Coordinator has a network address of "0", it can be addressed by its 16-bit network address.

To send a transmission to a Coordinator using its 16-bit network address:

Set the Destination Address of the transmitting module as shown below:

AT Firmware
 DL (Destination Low Address) = 0
 DH (Destination High Address) = 0

API Firmware
 Set the 64-bit destination address field in the API transmit frame to
 0x0000000000000000.

Broadcast Addressing

Broadcast transmissions are sent using a 64-bit address of 0x0000FFFF. Any RF module in the PAN will accept a packet that contains a broadcast address. When configured to operate in Broadcast Mode, receiving modules do not send ACKs (Acknowledgements).

To send a broadcast packet to all modules

Set the Destination Addresses of the transmitting module as shown below:

AT Firmware
 DL (Destination Low Address) = 0x0000FFFF
 DH (Destination High Address) = 0x00000000

API Firmware
 Set the 64-bit destination address field in the API transmit frame to 0x000000000000FFFF.

NOTE: When programming the module, parameters are entered in hexadecimal notation (without the "0x" prefix). Leading zeros may be omitted.

Refer to the "Broadcast Transmissions" for more information.

4.2.2. Application-layer Addressing

Application-layer addressing allows the application to specify endpoint and cluster ID values for each transmission. Addressing multiple endpoints and cluster IDs can be accomplished by explicitly setting these values as needed.

In AT firmware, application-layer addressing must be enabled using the ZA command. When application-layer addressing is enabled, the DE and SE commands specify the source and destination endpoints, and the CI command sets the cluster ID that will be used in the transmission.

In API firmware, the Explicit Addressing ZigBee Command frame (0x11) can be used to configure the endpoint and cluster ID addressing parameters as needed. The destination device can indicate application-layer addressing information depending on the AO parameter. Some endpoint values are reserved for use by the XBee Series 2 modules and should not be used. Please refer to the following tables for these values:

Table 4-03. XBee Series 2 Endpoint allocation

Endpoint	Description
0	ZigBee Device Objects endpoint. Reserved for ZigBee stack.
0x01 - 0xDB (219)	Available endpoints
0xDC (220) - 0xEE (238)	Reserved for Digi Use
0xE6 (230)	Command Endpoint
0xE8 (232)	Data Endpoint
0xEF (239) - 0xF0 (240)	Reserved for Ember Use

4.2.3. XBee Series 2 Binding Table

The XBee Series 2 modules maintain a binding table that contains addressing information for all non-broadcast RF transmissions and receptions. The binding table contains a destination 64-bit address, a type field, and endpoints for each transmission. Binding table entries can be accessed

by setting the BI command to a valid index in AT firmware, or by using the Binding Table API Command frame in the API firmware. The binding table entries are organized as follows.

Table 4-04.

Binding Table Index	Name	Access
0	Coordinator Binding	Read-Only
1	Tx-Aggregation Binding	Read-Only
2	Tx-Explicit Binding	Read-Write
3-4	Reserved	Read-Only
5-6	Command Binding	Read-Only
7-10	Received Data Bindings	Read-Only
11-12	User Bindings.	Read-Write

Coordinator Binding

The coordinator binding contains the 64-bit address of the coordinator. This table entry is populated when the device joins the network.

Tx-Aggregation Binding

This binding table entry contains the 64-bit address of the aggregate (sink) node if one exists. Data can be sent to the aggregate node by addressing this index in the binding table.

Tx-Explicit Binding

The Tx-Explicit binding table entry contains the destination address and endpoint information from the last explicit transmission that was issued. This entry is modified whenever explicit addressing is used in either the AT or API firmware as described in the "XBee Series 2 Addressing" section.

Command Binding

If a remote command request is received, the command binding entry stores information from the device that initiated the command. For example, if the ND or DN command is issued, this binding table entry would contain the source address of the device that sent the ND command.

Received Data Bindings

The received data bindings contain addressing information for the last three received data packets. The fourth entry is marked invalid. When a data packet is received, the address and endpoint information is stored into the invalid entry. Then, the oldest entry is made invalid. Thus, once an entry is created in the Received Data binding indexes, it will remain valid until three more RF data packets are received.

Figure 4-09. Demonstration of how entries in the received data bindings are replaced when an RF data packet is received.

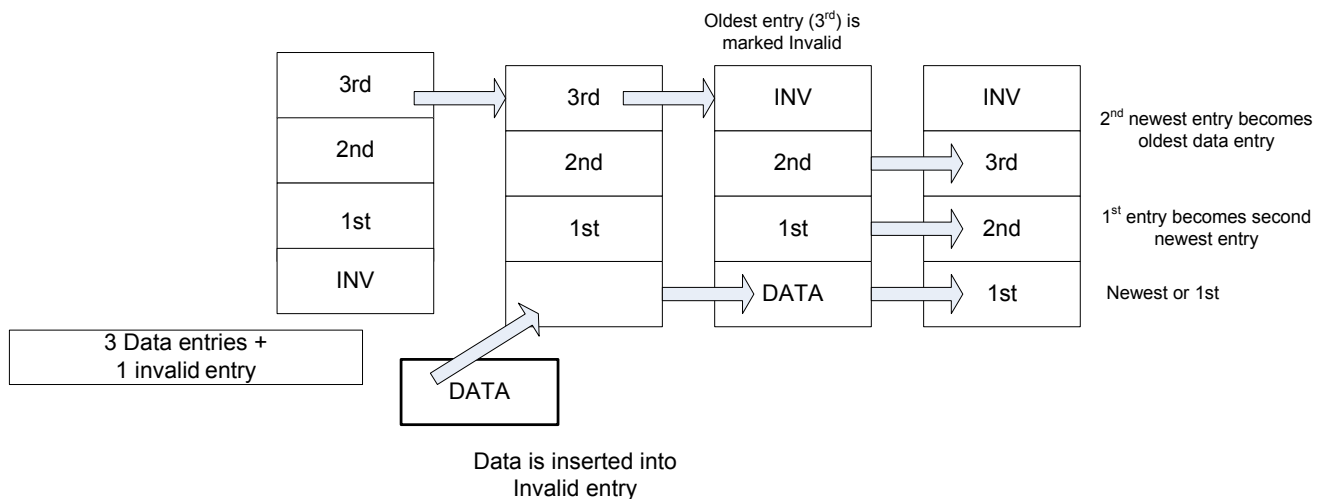

User Bindings

These entries can be created and maintained by the application if needed. The following commands can be used to modify the user bindings. See the command descriptions for formatting details.

Table 4-05.

Command	Name	Description
B+	Add Binding	Creates a binding table entry at a specified User Binding index.
B-	Remove Binding	Removes a binding from a specified User Binding index.
BV	View Binding	Views one or more bindings in the binding table.
WB	Write Binding	Writes the binding table to non-volatile memory.

4.2.4. XBee Series 2 Endpoint Table

The XBee Series 2 modules maintain a table of supported endpoints. If an endpoint will be used as the source endpoint in a data transmission, the endpoint must first be defined in the endpoint table.

The XBee Series 2 endpoint table operates similar to the binding table. Entries may be added, removed, or viewed using the E+, E-, and EV commands respectively. Some table entries are reserved for special purposes

Table 4-06.

Endpoint Table Index	Name	Access
0	Command Endpoint	Read-Only
1	Data Endpoint	Read-Only
2	Tx-Explicit Endpoint	Read-Write
3- 4	User Endpoints	Read-Write

Command Endpoint

The command endpoint is used to send or reply to various commands. This endpoint must exist in the application.

Data Endpoint

This endpoint is used to send serial data to other XBee Series 2 modules. It must always exist in the application.

Tx-Explicit Endpoint

This entry is used as needed to define the source endpoint that must be defined for a data transmission. If a transmit request is made, and the specified source endpoint does not exist, it will be created temporarily at this endpoint table index.

User Endpoints

User endpoints are controlled entirely by the application. These endpoints may be added, removed, or viewed in the API firmware using the following commands. See the command descriptions for command formatting details. At present, changes to the endpoint table are saved to non-volatile memory when WR is issued.

Table 4-07. ZigBee Data Transmissions Addressing Fields

Command	Name	Description
E+	Add Endpoint	Creates an endpoint entry at a specified user endpoint index.
E-	Remove Endpoint	Removes an endpoint entry from a specified user endpoint index.
EV	View Endpoint	Views one or more endpoints in the endpoint table.

4.3. Sleep Mode Operation

XBee Series 2 modules support sleep mode operation in the Router / End Device firmware. Sleep modes allow a ZigBee end device to enter a low power mode when idle and wake as needed to transmit or receive data. See Chapter 2 "RF Module Operation" for more information about different sleep modes.

4.3.1. End Device Operation

ZigBee end devices rely on a parent (router or coordinator) to remain awake and receive any data packets destined for the end device. When the end device wakes from sleep, it sends a transmission (poll request) to its parent asking if the parent has received any RF data destined for the end device. The parent, upon receipt of the poll request, will send an RF response and the buffered data (if present).

If the end device is awake with the ST timer running (SM=4), or if Sleep_RQ is de-asserted (SM=1), the end device will send poll requests every 100ms to ensure it receives any new RF data from its parent.

4.3.2. Parent Operation

When an end device joins a ZigBee PAN, it becomes a child of the (coordinator or router) device it joined to, and the device that allowed the join becomes the end device's parent. Thereafter, the parent will manage RF data packets for the end device. If the parent receives an RF packet destined for the end device, it will store the data packet until one of the following occurs:

- The parent runs out of storage space and cannot store a new packet.
- A packet has been stored for a period of time.
- The destination end device child sends a poll request transmission to request the data packet.

When the parent stores a packet destined for an end device child, it stores the packet for a maximum time set by SP. The actual storage time is computed as (SP * 2.5), not exceeding 30 seconds. If end devices implement cyclic sleep, SP should be set the same on a parent as it is on their sleeping end device children. In the case of pin sleep, where RF data could be received, the end device should wake within SP time to ensure data is not lost.

4.4. I/O Line Configuration

The XBee Series 2 modules support both analog input and digital IO line modes on several configurable pins.

Configuring A/D and Digital Lines

The following table lists the pin functions supported on the modules

Table 4-08.

Module Pin Names	Module Pin Numbers	Configuration Command
CD/DIO12	4	P2
PWM0/RSSI/DIO10	6	P0
PWM/DIO11	7	P1
SLEEP_RQ/DIO8	9	IO Configuration not supported
DIO4	11	D4
CTS/DIO7	12	D7
ON_SLEEP/DIO9	13	IO Configuration not supported
ASSOC/DIO5	15	D5

Table 4-08.

Module Pin Names	Module Pin Numbers	Configuration Command
RTS/DIO6	16	D6
AD3/DIO3	17	D3
AD2/DIO2	18	D2
AD1/DIO1	19	D1
AD0/DIO0	20	D0

Setting the configuration command that corresponds to a particular pin will configure the pin. Parameters for the pin configuration commands typically include the following:

Table 4-09.

Pin Command Parameter	Description
0	Unmonitored digital input
1	Reserved for pin-specific alternate functionalities
2	Analog input, single ended (A/D pins only)
3	Digital input, monitored
4	Digital output, default low
5	Digital output, default high
6-9	Alternate functionalities, where applicable

See the command table for more information. Pullup resistors for each digital input can be enabled using the PR command.

Sampling A/D and Digital Input Lines

The IS command can be used to sample the current value of all enabled A/D and digital input lines.

Bytes	Name	Description
1	Sample sets in packet	Number of sample sets in the packet
2	Digital Channel Mask	Each bit in the digital channel mask corresponds to one digital IO line. The bits, from LSB to MSB, correspond to DIO0-DIO5 on the module. For example a digital channel mask of 0x002F means DIO0,1,2,3, and 5 are enabled as digital input lines.
1	Analog Channel Mask	Each bit in the analog channel mask corresponds to one analog channel. The bits from LSB to MSB correspond to AIN0-AIN7 on the module. For example, if the analog channel mask is 0x06, AIN1 and AIN3 are enabled as analog input lines.
Var	Sampled Data Set	A sample set consisting of 1 sample for each enabled ADC and/or DIO channel. If any digital input lines are enabled, the first two bytes indicate the state of all enabled digital input lines. Each bit in these two bytes corresponds to one digital IO line, similar to the way each bit in the digital channel mask corresponds. Note: only the digital input lines that are enabled in the digital channel mask have valid readings. Channels that are not enabled as digital input lines will return a 0 in the sampled data set. If no pins are configured as digital inputs, these 2 bytes will be omitted. Following the digital input data, if any, each enabled analog channel will return 2 bytes (10bits). The analog data is scaled such that 0 represents 0V, and 0x3FF=1.2V. The analog input lines cannot measure more than 1.2V. Information for each enabled analog channel is returned in order, starting with AIN0 and finishing with AIN4. Only enabled analog input channels will return data.

The AT firmware returns a carriage return delimited list containing the above-listed fields. The API firmware returns an AT command response API frame with the IO data included in the command data portion of the packet.

Example	Sample AT Response
0x01\r	[1 sample set]
0x0C0C\r	[Digital Inputs: DIO 2, 3, 10, 11 low]
0x03\r	[Analog Inputs: A/D 0, 1]
0x0408\r	[Digital input states: DIO 3, 10 high, DIO 2, 11 low]
0x03D0\r	[Analog input ADIO 0= 0x3D0]
0x0124\r	[Analog input ADIO 1=0x120]

To convert the A/D reading to mV, do the following:

$$AD(mV) = (ADIO \text{ reading} / 0x3FF) * 1200mV$$

The reading in the sample frame represent voltage inputs of 1144.9 and 342.5mV for ADIO0 and ADIO1 respectively.

5. Advanced Features

The XBee Series 2 modules come with several features to assist with discovering, configuring, and testing ZigBee networks. These features include

- Device Discovery
- Remote Configuration
- Loopback Testing
- Join Indicators
- Manual Device Identification
- Battery Life Monitoring.

5.1. Device Discovery

The Node Discovery command can be used to discover all modules that have joined a ZigBee PAN. Issuing ND sends a broadcast node discovery command throughout the PAN. All devices that receive the command will send a response that includes the device's 64-bit address, 16-bit address, and NI-string (see NI command). This command is useful for generating a list of all module addresses in a PAN.

5.2. Remote Configuration

The API firmware has provisions to configure the command registers of remote devices using the Remote Command Request API frame (see Chapter 7 - API Operation). Commands can be sent to a remote module to read or set different command parameters.

5.3. Loopback Testing

Range and link quality can be tested easily using a software loopback data mode. To send a message to a remote device and have the data be returned to the sender, the data should be addressed to the loopback cluster ID (0x12) on the data endpoint (0xE6) of the remote device.

5.3.1. AT Firmware

Set the ZA command to 1 and set the CI command value to 0x12. The SE and DE commands should be set to 0xE8 (default value). The DH and DL commands should be set to the 64-bit address of the remote. After exiting command mode, serial data should be transmitted to the remote device and returned to the sender.

5.3.2. API Firmware

Send an Explicit Addressing ZigBee Command frame using 0x12 as the cluster ID and 0xE8 as the source and destination endpoint. Data packets received by the remote should be echoed back to the sender.

5.4. Join Indicators

The JN command can be used to send a message to the coordinator when a router or end device joins the network. If JN is set to enable join notifications, an ND response packet will be sent to the coordinator when the device joins the PAN. (Only API coordinators will display the join notification.) The format of this packet on the coordinator depends on the AO setting.

5.5. Manual Device Identification

The D0 command can be set to send a node identification packet to the coordinator when a low-to-high edge is detected on module pin 20. The node identification packet includes the XBee module's

64-bit and 16-bit addresses and its NI-string. (Only API coordinators will display the node identification packet.) Connecting a push-button to module pin 20 provides a simple mechanism for manually identifying a module to the coordinator during deployment.

5.6. Battery Life Monitoring

The %V command can be used to determine the supply voltage on a device. This command can also be sent (in API firmware) to remote devices in the PAN to monitor their supply voltage level.

6. XBee Series 2 Command Reference Tables

Special

Table 6-01. Special Commands

AT Command	Name and Description	Node Type ¹	Parameter Range	Default
WR	Write. Write parameter values to non-volatile memory so that parameter modifications persist through subsequent resets. Note: Once WR is issued, no additional characters should be sent to the module until after the "OK\r" response is received.	CRE	--	--
WB	Write Binding Table. Writes the current binding table to non-volatile memory.	CRE	--	--
RE	Restore Defaults. Restore module parameters to factory defaults. RE command does not reset the ID parameter.	CRE	--	--
FR	Software Reset. Reset module. Responds immediately with an "OK" then performs a reset ~2 seconds later. Use of the FR command will cause a network layer restart on the node if SC or ID were modified since the last reset.	CRE	--	--
NR	Network Reset. Reset network layer parameters on one or more modules within a PAN. Responds immediately with an "OK" then causes a network restart. All network configuration and routing information is consequently lost. <i>If NR = 0:</i> Resets network layer parameters on the node issuing the command. <i>If NR = 1:</i> Sends broadcast transmission to reset network layer parameters on all nodes in the PAN.	CRE	0 - 1	--

Node types that support the command: C = Coordinator, R = Router, E = End Device

Addressing

Table 6-02. Addressing Commands)

AT Command	Name and Description	Node Type ¹	Parameter Range	Default
DH ²	Destination Address High. Set/Get the upper 32 bits of the 64-bit destination address. When combined with DL, it defines the destination address used for transmission. 0x000000000000FFFF is the broadcast address for the PAN. DH is not supported in API Mode. 0x0000000000000000 is the Coordinator's 16-bit network address.	CRE	0 - 0xFFFFFFFF	0
DL ²	Destination Address Low. Set/Get the lower 32 bits of the 64-bit destination address. When combined with DH, DL defines the destination address used for transmission. 0x000000000000FFFF is the broadcast address for the PAN. DL is not supported in API Mode. 0x0000000000000000 is the Coordinator's 16-bit network address.	CRE	0 - 0xFFFFFFFF	0xFFFF(Coordinator) 0 (Router/End Device)
MY	16-bit Network Address. Get the 16-bit network address of the module.	CRE	0 - 0xFFFE [read-only]	0xFFFE
MP	16-bit Parent Network Address. Get the 16-bit parent network address of the module.	E	0 - 0xFFFE [read-only]	0xFFFE
SH	Serial Number High. Read high 32 bits of the RF module's unique IEEE 64-bit address. 64-bit source address is always enabled.	CRE	0 - 0xFFFFFFFF [read-only]	factory-set
SL	Serial Number Low. Read low 32 bits of the RF module's unique IEEE 64-bit address. 64-bit source address is always enabled.	CRE	0 - 0xFFFFFFFF [read-only]	factory-set
NI	Node Identifier. Stores a string identifier. The register only accepts printable ASCII data. In AT Command Mode, a string can not start with a space. A carriage return ends the command. Command will automatically end when maximum bytes for the string have been entered. This string is returned as part of the ND (Node Discover) command. This identifier is also used with the DN (Destination Node) command.	CRE	20-Byte printable ASCII string	--
DD	Device Type Identifier. Stores a device type value. This value can be used to differentiate multiple XBee-based products.	CRE	0 - 0xFFFF [read-only]	0
ZA ²	ZigBee Application Layer Addressing. Set/read the Zigbee application layer addressing enabled attribute. If enabled, data packets will use the SE, DE, and CI commands to address Zigbee application layer source and destination endpoints, and the cluster ID fields in all data transmissions. ZA is only supported in the AT firmware.	CRE	0 - 1	0
SE ²	Source Endpoint. Set/read the ZigBee application layer source endpoint value. If ZigBee application layer addressing is enabled (ZA command), this value will be used as the source endpoint for all data transmissions. SE is only supported in AT firmware. The default value 0xE8 (Data endpoint) is the Digi data endpoint	CRE	1 - 0xEF	0xE8
DE ²	Destination Endpoint. Set/read Zigbee application layer destination ID value. If ZigBee application layer addressing is enabled (ZA command), this value will be used as the destination endpoint all data transmissions. DE is only supported in AT firmware. The default value (0xE8) is the Digi data endpoint.	CRE	0 - 0xEF	0xE8

Table 6-02. Addressing Commands

AT Command	Name and Description	Node Type ¹	Parameter Range	Default
CI ²	Cluster Identifier. Set/read Zigbee application layer cluster ID value. If ZigBee application layer addressing is enabled (ZA command), this value will be used as the cluster ID for all data transmissions. CI is only supported in AT firmware. The default value is 0x11 (Transparent data cluster ID).	CRE	0 - 0xFF	0x11
BI ²	Binding Table Index. Set/read the binding table index value. If this value is set to a valid binding table index, the addressing information at that index in the binding table will be used for all data transmissions. BI is only supported in AT firmware	CRE	0 - 0xFF	0xFF

1. Node types that support the command: C=Coordinator, R=Router, E=End Device
2. Command supported by modules using AT Command firmware only

Networking & Security

Table 6-03. Networking Commands

AT Command	Name and Description	Node Type ¹	Parameter Range	Default
CH	Operating Channel. Read the channel number used for transmitting and receiving between RF modules. Uses 802.15.4 channel numbers. A value of 0 means the device has not joined a PAN and is not operating on any channel.	CRE	0, 0x0B-0x1A (XBee)	0
ID	PAN ID. Set/Get the PAN (Personal Area Network) ID. Coordinator - Set the preferred Pan ID. Set ID = 0xFFFF to auto-select. Router / End Device - Set the desired Pan ID. When the device searches for a Coordinator, it attempts to only join to a parent that has a matching Pan ID. Set ID = 0xFFFF to join a parent operating on any Pan ID. Changes to ID should be written to non-volatile memory using the WR command.	CRE	0 - 0x3FFF, 0xFFFF	0x0234 (291d)
BH	Broadcast Hops. Set/Read the maximum number of hops for each broadcast data transmission. Setting this to 0 will use the maximum number of hops.	CRE	0 - 0x0F	--
NT	Node Discover Timeout. Set/Read the amount of time a node will spend discovering other nodes when ND or DN is issued.	CRE	0 - 0xFC [x 100 msec]	0x3C (60d)
ND	Node Discover. Discovers and reports all RF modules found. The following information is reported for each module discovered. MY<CR> SH<CR> SL<CR> NI<CR> (Variable length) PARENT_NETWORK_ADDRESS (2 Bytes)<CR> DEVICE_TYPE<CR> (1 Byte: 0=Coord, 1=Router, 2=End Device) STATUS<CR> (1 Byte: Reserved) PROFILE_ID<CR> (2 Bytes) MANUFACTURER_ID<CR> (2 Bytes) <CR> After (NT * 100) milliseconds, the command ends by returning a <CR>. ND also accepts a Node Identifier (NI) as a parameter (optional). In this case, only a module that matches the supplied identifier will respond. If ND is sent through the API, each response is returned as a separate AT_CMD_Response packet. The data consists of the above listed bytes without the carriage return delimiters. The NI string will end in a "0x00" null character. The radius of the ND command is set by the BH command.	CRE	optional 20-Byte NI or MY value	--
DN	Destination Node. Resolves an NI (Node Identifier) string to a physical address (case-sensitive). The following events occur after the destination node is discovered: <AT Firmware> 1. DL & DH are set to the extended (64-bit) address of the module with the matching NI (Node Identifier) string. 2. OK (or ERROR)r is returned. 3. Command Mode is exited to allow immediate communication <API Firmware> 1. The 16-bit network and 64-bit extended addresses are returned in an API Command Response frame. If there is no response from a module within (NT * 100) milliseconds or a parameter is not specified (left blank), the command is terminated and an "ERROR" message is returned. In the case of an ERROR, Command Mode is not exited. The radius of the DN command is set by the BH command.	CRE	up to 20-Byte printable ASCII string	--
JN	Join Notification. Set/read the join notification value. If enabled, the device will send a transmission after joining a PAN, identifying itself to the coordinator.	RE	0 - Join notification disabled 1 - Send notification only to coordinator after joining PAN	1

Table 6-03. Networking Commands

AT Command	Name and Description	Node Type ¹	Parameter Range	Default																
SC	<p>Scan Channels. Set/Read the list of channels to scan.</p> <p>Coordinator - Bit field list of channels to choose from prior to starting network.</p> <p>Router/End Device - Bit field list of channels that will be scanned to find a Coordinator/Router to join.</p> <p>Changes to SC should be written using WR command.</p> <p>Bit (Channel):</p> <table border="0"> <tr> <td>0 (0x0B)</td> <td>4 (0x0F)</td> <td>8 (0x13)</td> <td>12 (0x17)</td> </tr> <tr> <td>1 (0x0C)</td> <td>5 (0x10)</td> <td>9 (0x14)</td> <td>13 (0x18)</td> </tr> <tr> <td>2 (0x0D)</td> <td>6 (0x11)</td> <td>10 (0x15)</td> <td>14 (0x19)</td> </tr> <tr> <td>3 (0x0E)</td> <td>7 (0x12)</td> <td>11 (0x16)</td> <td>15 (0x1A)</td> </tr> </table>	0 (0x0B)	4 (0x0F)	8 (0x13)	12 (0x17)	1 (0x0C)	5 (0x10)	9 (0x14)	13 (0x18)	2 (0x0D)	6 (0x11)	10 (0x15)	14 (0x19)	3 (0x0E)	7 (0x12)	11 (0x16)	15 (0x1A)	CRE	1 - 0xFFFF[bitfield]	0x1FFE
0 (0x0B)	4 (0x0F)	8 (0x13)	12 (0x17)																	
1 (0x0C)	5 (0x10)	9 (0x14)	13 (0x18)																	
2 (0x0D)	6 (0x11)	10 (0x15)	14 (0x19)																	
3 (0x0E)	7 (0x12)	11 (0x16)	15 (0x1A)																	
SD	<p>Scan Duration. Set/Read the scan duration exponent. Changes to SD should be written using WR command.</p> <p>Coordinator - Duration of the Active and Energy Scans (on each channel) that are used to determine an acceptable channel and Pan ID for the Coordinator to startup on.</p> <p>Router / End Device - Duration of Active Scan (on each channel) used to locate an available Coordinator / Router to join during Association.</p> <p>Scan Time is measured as:(# Channels to Scan) * (2 ^ SD) * 15.36ms - The number of channels to scan is determined by the SC parameter. The XBee can scan up to 16 channels (SC = 0xFFFF).</p> <p>Sample Scan Duration times (13 channel scan):</p> <p>If SD = 0, time = 0.200 sec SD = 2, time = 0.799 sec SD = 4, time = 3.190 sec SD = 6, time = 12.780 sec</p>	CRE	0 - 7 [exponent]	3																
NJ	<p>Node Join Time. Set/Read the time that a Coordinator/Router allows nodes to join. This value can be changed at run time without requiring a Coordinator or Router to restart. The time starts once the Coordinator or Router has started. The timer is reset on power-cycle or when NJ changes.</p>	CR	0 – 0x40, 0xFF [x 1 sec]	0xFF (always allows joining)																
AR	<p>Aggregate Routing Notification. Set/read time between consecutive aggregate route broadcast messages. If used, AR should be set on only one device to enable many-to-one routing to the device. Setting AR to 0 only sends one broadcast</p>	CR	0 - 0xFF	0xFF																
AI	<p>Association Indication. Read information regarding last node join request:</p> <p>0x00 - Successful completion - Coordinator started or Router/End Device found and joined with a parent.</p> <p>0x21 - Scan found no PANs</p> <p>0x22 - Scan found no valid PANs based on current SC and ID settings</p> <p>0x23 - Valid Coordinator or Routers found, but they are not allowing joining (NJ expired)</p> <p>0x27 - Node Joining attempt failed</p> <p>0x2A - Coordinator Start attempt failed'</p> <p>0xFF - Scanning for a Parent</p>	CRE	0 - 0xFF [read-only]	--																

RF Interfacing

Table 6-04. RF Interfacing Commands

AT Command	Name and Description	Node Type ¹	Parameter Range	Default
PL	<p>Power Level. Select/Read the power level at which the RF module transmits conducted power.</p>	CRE	0 - 4 (XBee) 0 = -10 / 10 dBm 1 = -6 / 12 dBm 2 = -4 / 14 dBm 3 = -2 / 16 dBm 4 = 0 / 18 dBm	4
PM	<p>Power Mode. Set/read the power mode of the device. Enabling boost mode will improve the receive sensitivity by 1dB and increase the transmit power by 2dB</p>	CRE	0-1, 0= Boost mode disabled, 1= Boost mode enabled.	1

1. Node types that support the command: C = Coordinator, R = Router, E = End Device

Serial Interfacing (I/O)

Table 6-05. Serial Interfacing Commands

AT Command	Name and Description	Node Type ¹	Parameter Range	Default
AP ²	<p>API Enable. Enable API Mode.</p> <p>The AP parameter is only applicable when using modules that contain the following firmware versions:1.1xx (coordinator), 1.3xx (router/end device)</p>	CRE	1 - 2 1 = API-enabled 2 = API-enabled (w/escaped control characters)	1

Table 6-05. Serial Interfacing Commands

AT Command	Name and Description	Node Type ¹	Parameter Range	Default
AO ²	API Options. Configure options for API. Current options select the type of receive API frame to send out the Uart for received RF data packets.	CRE	0 - Default receive API indicators enabled 1 - Explicit Rx data indicator API frame enabled (0x91)	0
BD	Interface Data Rate. Set/Read the serial interface data rate for communication between the module serial port and host. Any value above 0x07 will be interpreted as an actual baud rate. When a value above 0x07 is sent, the closest interface data rate represented by the number is stored in the BD register.	CRE	0 - 7 (standard baud rates) 0 = 1200 bps 1 = 2400 2 = 4800 3 = 9600 4 = 19200 5 = 38400 6 = 57600 7 = 115200 0x80 - 0x38400 (non-standard rates)	3
RO	Packetization Timeout. Set/Read number of character times of inter-character silence required before packetization. Set (RO=0) to transmit characters as they arrive instead of buffering them into one RF packet.	CRE	0 - 0xFF [x character times]	3
D7	DIO7 Configuration. Select/Read options for the DIO7 line of the RF module.	CRE	0 = Disabled 1 = CTS Flow Control 3 = Digital input 4 = Digital output, low 5 = Digital output, high 6 = RS-485 transmit enable (low enable) 7 = RS-485 transmit enable (high enable)	1
D6	DIO6 Configuration. Configure options for the DIO6 line of the RF module.	CRE	0 - Disabled 1 - RTS Flow Control	0
D5	DIO5 Configuration. Configure options for the DIO5 line of the RF module.	CRE	0 = Disabled 1 = Associated indication LED 3 = Digital input 4 = Digital output, default low 5 = Digital output, default high	1

1. Node types that support the command: C = Coordinator, R = Router, E = End Device
2. Command supported by modules using API firmware only

I/O Commands

Table 6-06. I/O Commands

AT Command	Name and Description	Node Type ¹	Parameter Range	Default
P0	PWM0 Configuration. Select/Read function for PWM0.	CRE	0 = Disabled 1 = RSSI PWM 3 - Digital input, monitored 4 - Digital output, default low 5 - Digital output, default high	1
P1	DIO11 Configuration. Configure options for the DIO11 line of the RF module.	CRE	0 - Unmonitored digital input 3- Digital input, monitored 4- Digital output, default low 5- Digital output, default high	0

Table 6-06. I/O Commands

AT Command	Name and Description	Node Type ¹	Parameter Range	Default
P2	DIO12 Configuration. Configure options for the DIO12 line of the RF module.	CRE	0 - Unmonitored digital input 3- Digital input, monitored 4- Digital output, default low 5- Digital output, default high	0
RP	RSSI PWM Timer. Time RSSI signal will be output after last transmission. When RP = 0xFF, output will always be on.	CRE	0 - 0xFF [x 100 ms]	0x28 (40d)
IS	Force Sample Forces a read of all enabled digital and analog input lines.	CRE	--	--
D0	AD0/DIO0 Configuration. Select/Read function for AD0/DIO0.	CRE	0-5 0 – Disabled 1 - Node identification button enabled 2 - Analog input, single ended 3 – Digital input 4 – Digital output, low 5 – Digital output, high	1 (RE), 0 (C)
D1	AD1/DIO1 Configuration. Select/Read function for AD1/DIO1.	CRE	0, 2-5 0 – Disabled 2 - Analog input, single ended 3 – Digital input 4 – Digital output, low 5 – Digital output, high	0
D2	AD2/DIO2 Configuration. Select/Read function for AD2/DIO2.	CRE	0, 2-5 0 – Disabled 2 - Analog input, single ended 3 – Digital input 4 – Digital output, low 5 – Digital output, high	0
D3	AD3/DIO3 Configuration. Select/Read function for AD3/DIO3.	CRE	0, 2-5 0 – Disabled 2 - Analog input, single ended 3 – Digital input 4 – Digital output, low 5 – Digital output, high	0
D4	DIO4 Configuration. Select/Read function for DIO4.	CRE	0, 3-5 0 – Disabled 3 – Digital input 4 – Digital output, low 5 – Digital output, high	0
PR	Set/read the bit field that configures the internal pull-up resistor status for the I/O lines. "1" specifies the pull-up resistor is enabled. "0" specifies no pullup. Bits: 0 - DIO4 (Pin 11) 1 - AD3 / DIO3 (Pin 17) 2 - AD2 / DIO2 (Pin 18) 3 - AD1 / DIO1 (Pin 19) 4 - AD0 / DIO0 (Pin 20) 5 - RTS / DIO6 (Pin 16) 6 - DTR / Sleep Request / DIO8 (Pin 9) 7 - DIN / Config (Pin 3) 8 - Associate / DIO5 (Pin 15) 9 - On/Sleep / DIO9 (Pin 13) 10 - DIO12 (Pin 4) 11 - PWM0 / RSSI / DIO10 (Pin 6) 12 - PWM1 / DIO11 (Pin 7)	CRE	0 - 0x1FFF	0 - 0x1FFF

Diagnostics

Table 6-07. Diagnostics Commands

AT Command	Name and Description	Node Type ¹	Parameter Range	Default
VR	Firmware Version. Read firmware version of the module.	CRE	0 - 0xFFFF [read-only]	Factory-set
HV	Hardware Version. Read hardware version of the module.	CRE	0 - 0xFFFF [read-only]	Factory-set
%V	Supply Voltage. Reads the voltage on the Vcc pin. To convert the reading to a mV reading, divide the read value by 1023 and multiply by 1200. A %V reading of 0x8FE (2302 decimal) represents 2700mV or 2.70V.	CRE	-	-

1. Node types that support the command: C = Coordinator, R = Router, E = End Device

AT Command Options

Table 6-08. AT Command Options Commands

AT Command	Name and Description	Node Type ¹	Parameter Range	Default
CT ²	Command Mode Timeout. Set/Read the period of inactivity (no valid commands received) after which the RF module automatically exits AT Command Mode and returns to Idle Mode.	CRE	2 - 0x028F [x 100 ms]	0x64 (100d)
CN ²	Exit Command Mode. Explicitly exit the module from AT Command Mode.	CRE	--	--
GT ²	Guard Times. Set required period of silence before and after the Command Sequence Characters of the AT Command Mode Sequence (GT + CC + GT). The period of silence is used to prevent inadvertent entrance into AT Command Mode.	CRE	1 - 0x0CE4 [x 1 ms] (max of 3.3 decimal sec)	0x3E8 (1000d)
CC ²	Command Sequence Character. Set/Read the ASCII character value to be used between Guard Times of the AT Command Mode Sequence (GT + CC + GT). The AT Command Mode Sequence enters the RF module into AT Command Mode. CC command is only applicable when using modules that contain the following "AT Command" firmware versions: 8.0xx (Coordinator), 8.2xx (Router), 8.4xx (End Device)	CRE	0 - 0xFF	0x2B ('+' ASCII)

1. Node types that support the command: C = Coordinator, R = Router, E = End Device

2. Command supported by modules using AT Command firmware only

Sleep Commands

Table 6-09. Sleep Commands

AT Command	Name and Description	Node Type ¹	Parameter Range	Default
SM	Sleep Mode Sets the sleep mode on the RF module	RE	0-Sleep disabled 1-Pin sleep enabled 4-Cyclic sleep enabled Note: When SM=0, the device operates as a router. When SM changes to a non-zero value, the router leaves the network and rejoins as an end device. Only end devices can sleep	0
SN	Number of Sleep Periods. Sets the number of sleep periods to not assert the On/Sleep pin on wakeup if no RF data is waiting for the end device. This command allows a host application to sleep for an extended time if no RF data is present	RE	1 - 0xFFFF	1
SP	Sleep Period. This value determines how long the end device will sleep at a time, up to 28 seconds. (The sleep time can effectively be extended past 28 seconds using the SN command.) On the parent, this value determines how long the parent will buffer a message for the sleeping end device. It should be set at least equal to the longest SP time of any child end device.	CRE	0x20 - 0xAF0 x 10ms (Quarter second resolution)	0x20
ST	Time Before Sleep Sets the time before sleep timer on an end device. The timer is reset each time serial or RF data is received. Once the timer expires, an end device may enter low power operation. Applicable for cyclic sleep end devices only.	RE	1 - 0xFFFE (x 1ms)	0x1388 (5 seconds)

7. API Operation

As an alternative to Transparent Operation, API (Application Programming Interface) Operations are available. API operation requires that communication with the module be done through a structured interface (data is communicated in frames in a defined order). The API specifies how commands, command responses and module status messages are sent and received from the module using a UART Data Frame.

7.0.1. API Frame Specifications

Two API modes are supported and both can be enabled using the AP (API Enable) command. Use the following AP parameter values to configure the module to operate in a particular mode:

- AP = 1: API Operation
- AP = 2: API Operation (with escaped characters)

API Operation (AP parameter = 1)

When this API mode is enabled (AP = 1), the UART data frame structure is defined as follows:

Figure 7-01. UART Data Frame Structure:

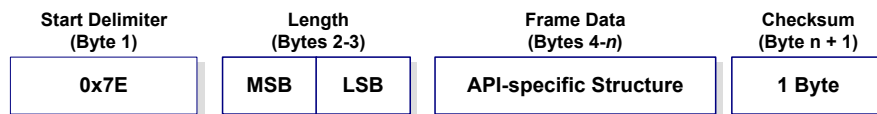

MSB = Most Significant Byte, LSB = Least Significant Byte

Any data received prior to the start delimiter is silently discarded. If the frame is not received correctly or if the checksum fails, the module will reply with a module status frame indicating the nature of the failure.

API Operation - with Escape Characters (AP parameter = 2)

When this API mode is enabled (AP = 2), the UART data frame structure is defined as follows:

Figure 7-02. UART Data Frame Structure - with escape control characters:



MSB = Most Significant Byte, LSB = Least Significant Byte

Escape characters. When sending or receiving a UART data frame, specific data values must be escaped (flagged) so they do not interfere with the data frame sequencing. To escape an interfering data byte, insert 0x7D and follow it with the byte to be escaped XOR'd with 0x20.

Data bytes that need to be escaped:

- 0x7E – Frame Delimiter
- 0x7D – Escape
- 0x11 – XON
- 0x13 – XOFF

Example - Raw UART Data Frame (before escaping interfering bytes):
 0x7E 0x00 0x02 0x23 0x11 0xCB
 0x11 needs to be escaped which results in the following frame:
 0x7E 0x00 0x02 0x23 0x7D 0x31 0xCB

Note: In the above example, the length of the raw data (excluding the checksum) is 0x0002 and the checksum of the non-escaped data (excluding frame delimiter and length) is calculated as:
 0xFF - (0x23 + 0x11) = (0xFF - 0x34) = 0xCB.

Checksum

To test data integrity, a checksum is calculated and verified on non-escaped data.

To calculate: Not including frame delimiters and length, add all bytes keeping only the lowest 8 bits of the result and subtract the result from 0xFF.

To verify: Add all bytes (include checksum, but not the delimiter and length). If the checksum is correct, the sum will equal 0xFF.

7.0.2. API Frames

Frame data of the UART data frame forms an API-specific structure as follows:

Figure 7-03. UART Data Frame & API-specific Structure:

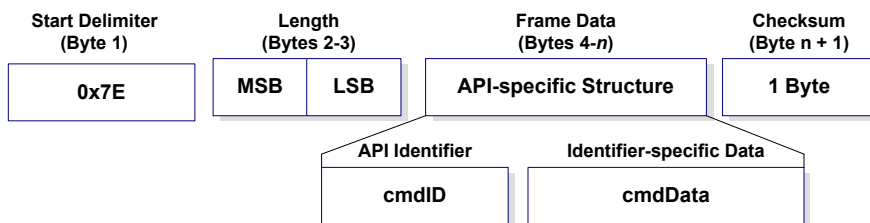

The cmdID frame (API-identifier) indicates which API messages will be contained in the cmdData frame (Identifier-specific data). Note that multi-byte values are sent big endian. The XBee Series 2 modules support the following API frames:

Table 7-010. API Frame Names and Values

API Frame Names	Values
Modem Status	0x8A
Advanced Modem Status	0x8C
AT Command	0x08
AT Command - Queue Parameter Value	0x09
AT Command Response	0x88
Remote Command Request	0x17
Remote Command Response	0x97
ZigBee Transmit Request	0x10
Explicit Addressing ZigBee Command Frame	0x11
ZigBee Transmit Status	0x8B

Table 7-010. API Frame Names and Values

API Frame Names	Values
ZigBee Receive Packet (AO=0)	0x90
ZigBee Explicit Rx Indicator (AO=1)	0x91
XBee Sensor Read Indicator (AO=0)	0x94
Node Identification Indicator (AO=0)	0x95

Modem Status

API Identifier Value: (0x8A)

RF module status messages are sent from the module in response to specific conditions.

Figure 7-04. Modem Status Frames

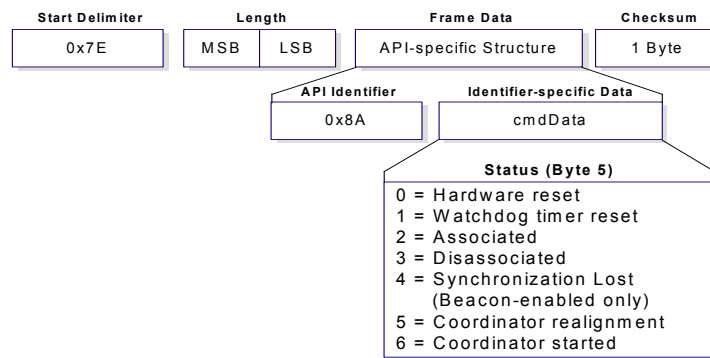

Advanced Modem Status Frame

API Identifier Value:(0x8C)

Note: This API Frame may change or become obsolete in future versions. Do not use.

Figure 7-05. Advanced Modem Status Frames: Do Not Use!

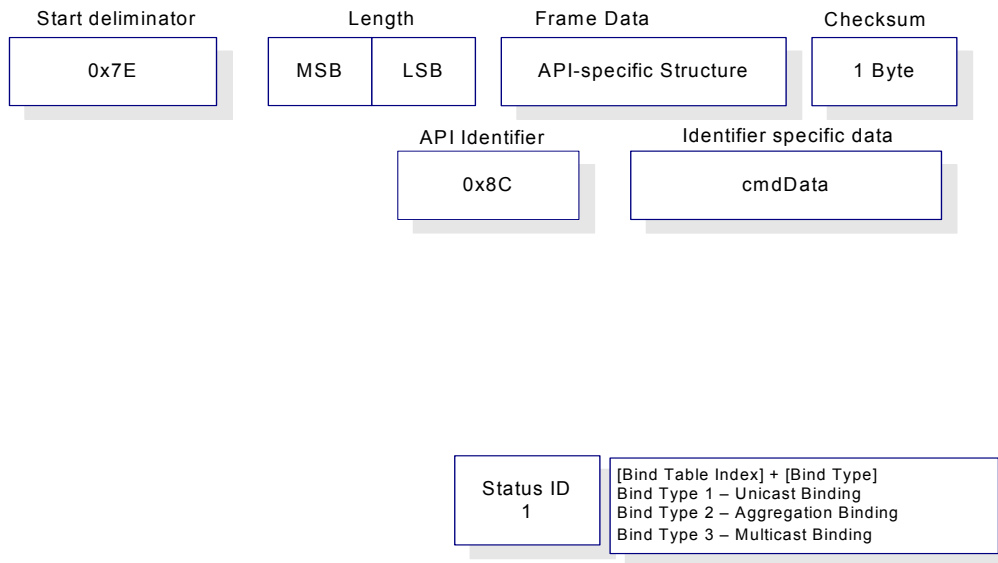

AT Command

API Identifier Value: (0x08)

Allows for module parameter registers to be queried or set.

Figure 7-6. AT Command Frames

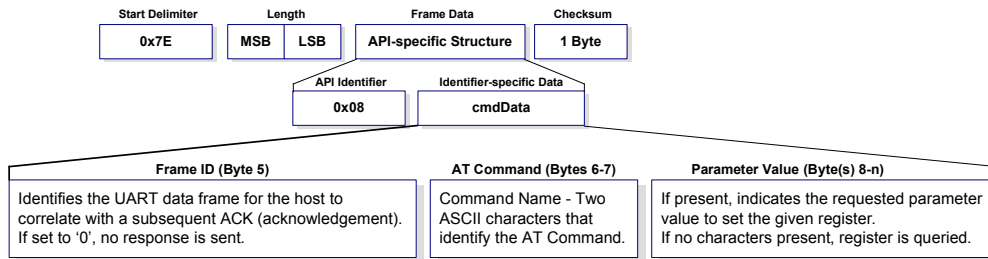
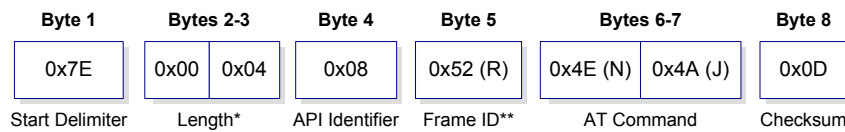

Figure 7-7. Example: API frames when reading the NJ parameter value of the module.



* Length [Bytes] = API Identifier + Frame ID + AT Command

** "R" value was arbitrarily selected.

Figure 7-8. Example: API frames when modifying the NJ parameter value of the module.

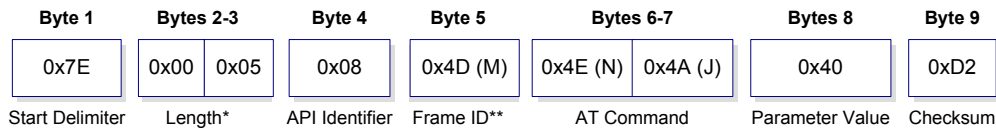

* Length [Bytes] = API Identifier + Frame ID + AT Command + Parameter Value

** "M" value was arbitrarily selected.

A string parameter used with the NI (Node Identifier), ND (Node Discover) and DH (Destination Address High) command is terminated with a 0x00 character.

AT Command - Queue Parameter Value

API Identifier Value: (0x09)

This API type allows module parameters to be queried or set. In contrast to the "AT Command" API type, new parameter values are queued and not applied until either the "AT Command" (0x08) API type or the AC (Apply Changes) command is issued. Register queries (reading parameter values) are returned immediately.

Figure 7-9. AT Command Frames

(Note that frames are identical to the "AT Command" API type except for the API identifier.)

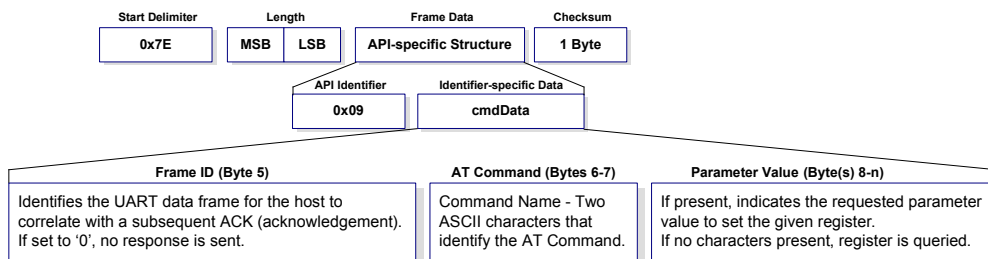

AT Command Response

API Identifier Value: (0x88)
 Response to previous command.

In response to an AT Command message, the module will send an AT Command Response message. Some commands will send back multiple frames (for example, the ND (Node Discover) command).

Figure 7-10. AT Command Response Frames.

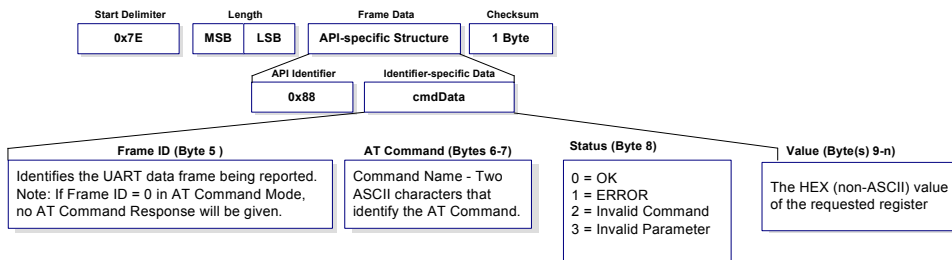

Remote AT Command Request

API Identifier Value: (0x17)

Allows for module parameter registers on a remote device to be queried or set

Figure 7-11. Remote AT Command Request

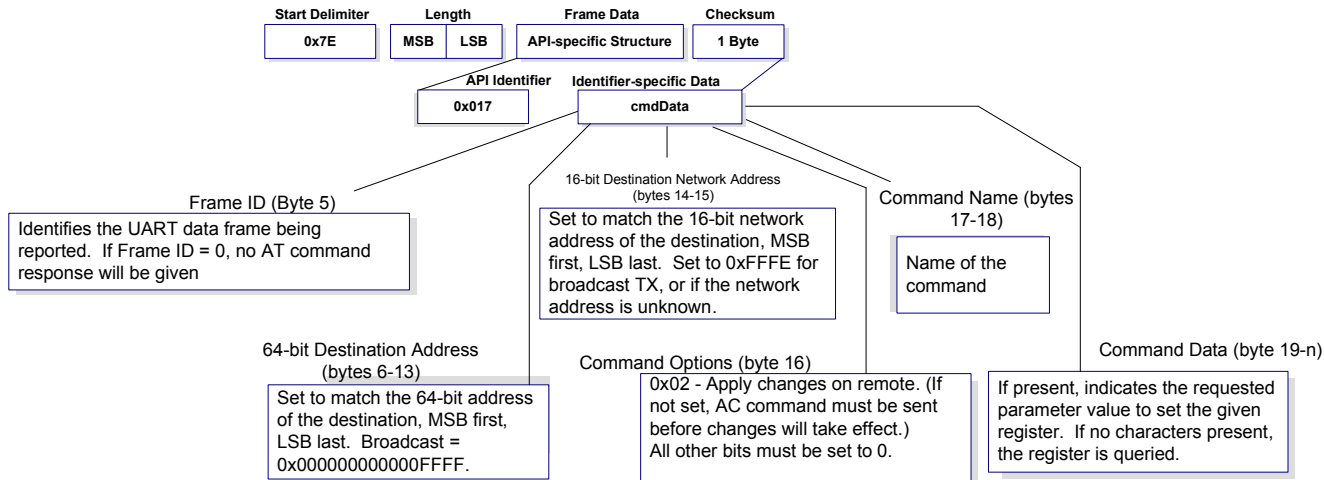

Remote Command Response

API Identifier Value: (0x97)

If a module receives a remote command response RF data frame in response to a Remote AT Command Request, the module will send a Remote AT Command Response message out the UART. Some commands may send back multiple frames--for example, Node Discover (ND) command.

Figure 7-12. Remote AT Command Response.

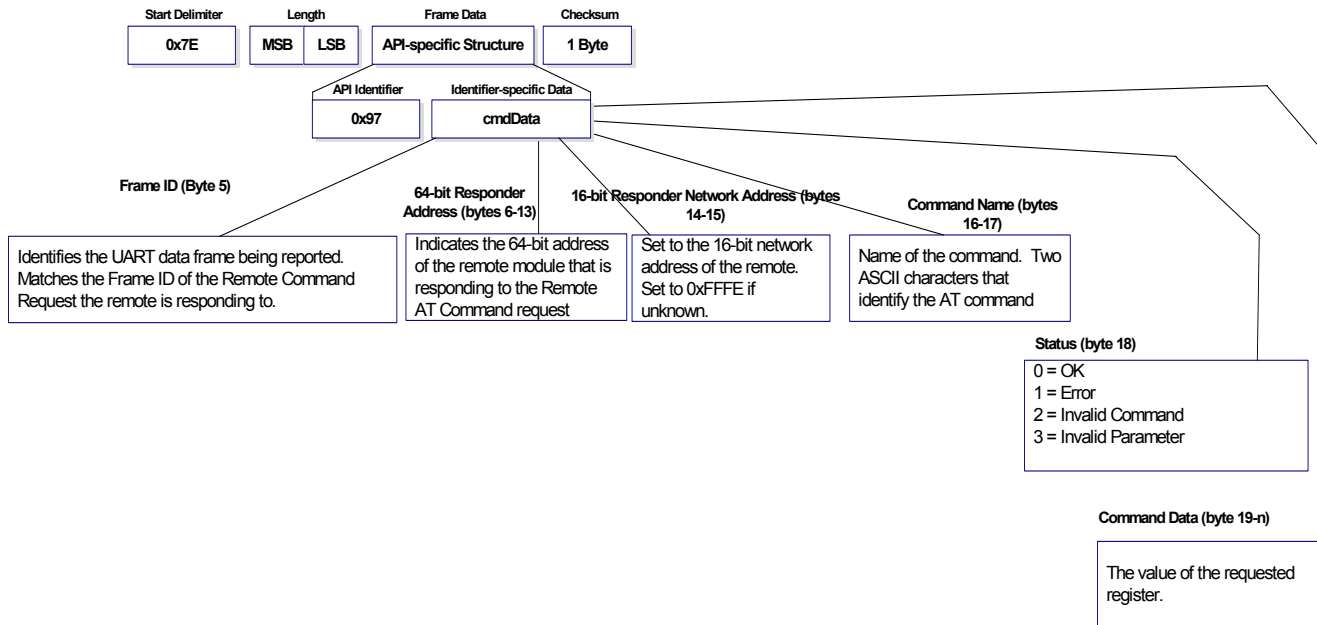

ZigBee Transmit Request

API Identifier Value: (0x10) A TX Request message will cause the module to send RF Data as an RF Packet.TX Packet Frames

Figure 7-13. ZigBee Transmit Request.

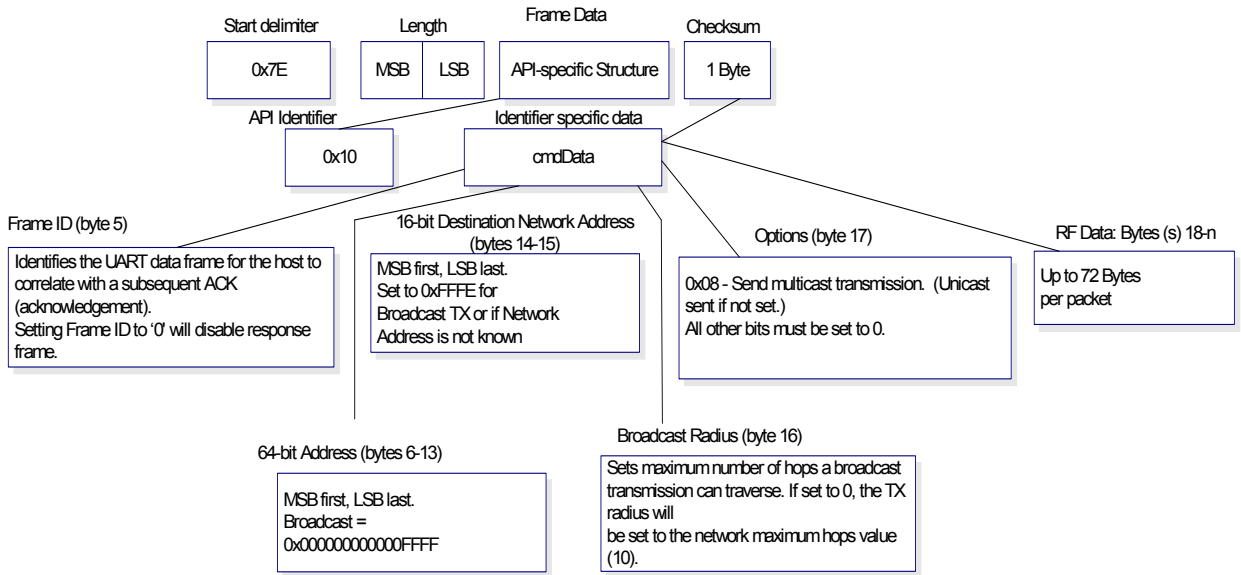

Explicit Addressing ZigBee Command Frame

API Identifier Value: (0x11)

Allows ZigBee application layer fields (endpoint and cluster ID) to be specified for a data transmission.

Figure 7-14. Explicit Addressing ZigBee Command Frame.

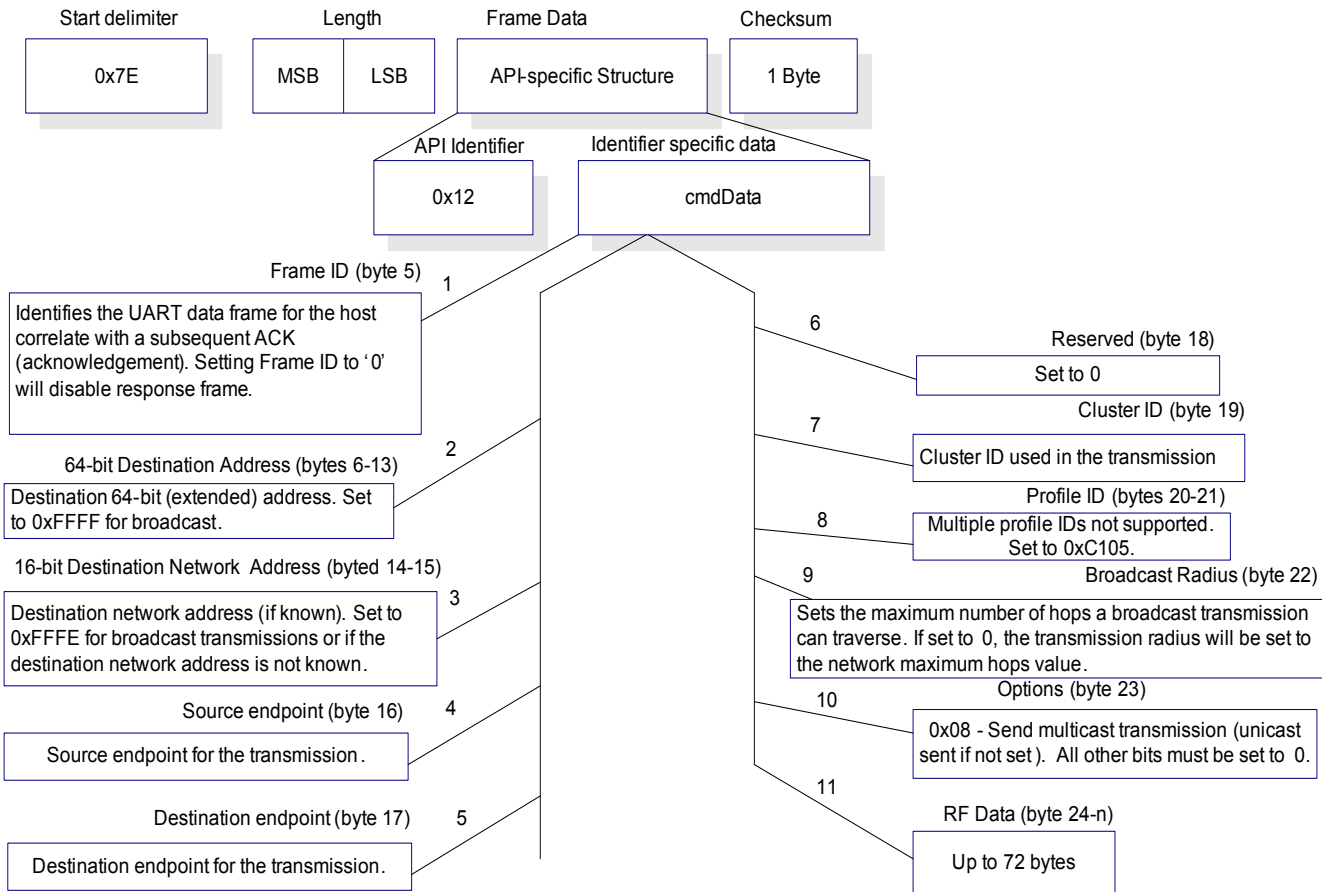

ZigBee Transmit Status

API Identifier Value: 0x8B

When a TX Request is completed, the module sends a TX Status message. This message will indicate if the packet was transmitted successfully or if there was a failure.

Figure 7-15. TX Status Frames

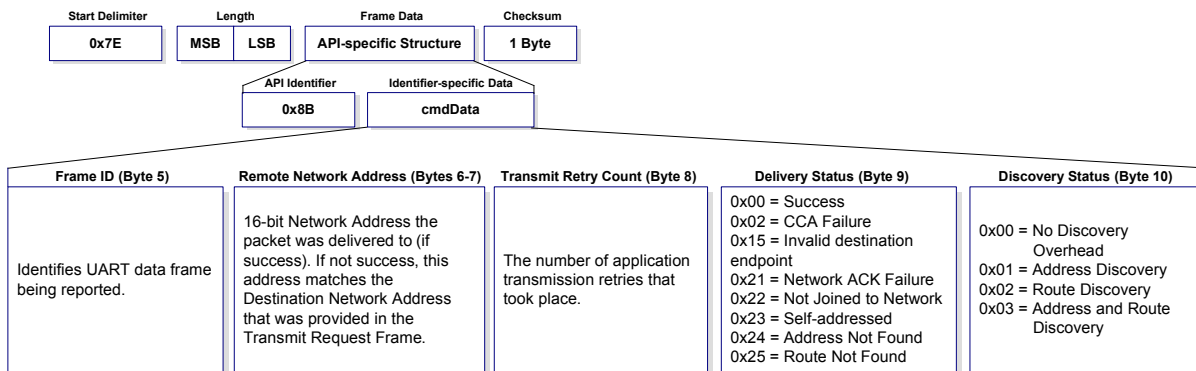

ZigBee Receive Packet

API Identifier Value: (0x90)

When the module receives an RF packet, it is sent out the UART using this message type.

Figure 7-16. RX Packet Frames

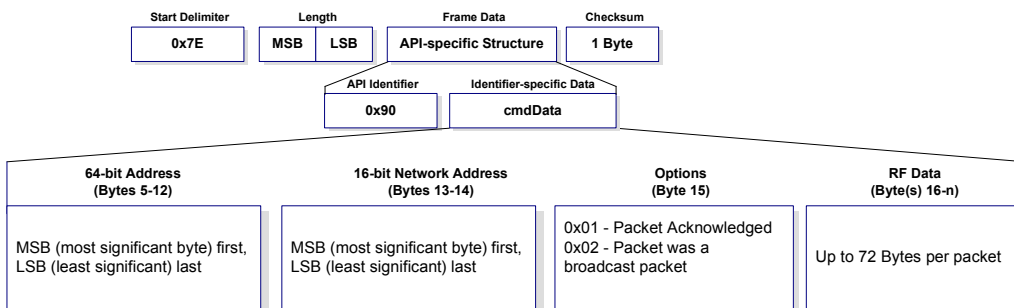

ZigBee Explicit Rx Indicator

API Identifier Value:(0x91)

When the modem receives a ZigBee RF packet it is sent out the UART using this message type (when AO=1).

Figure 7-17. ZigBee Explicit Rx Indicators

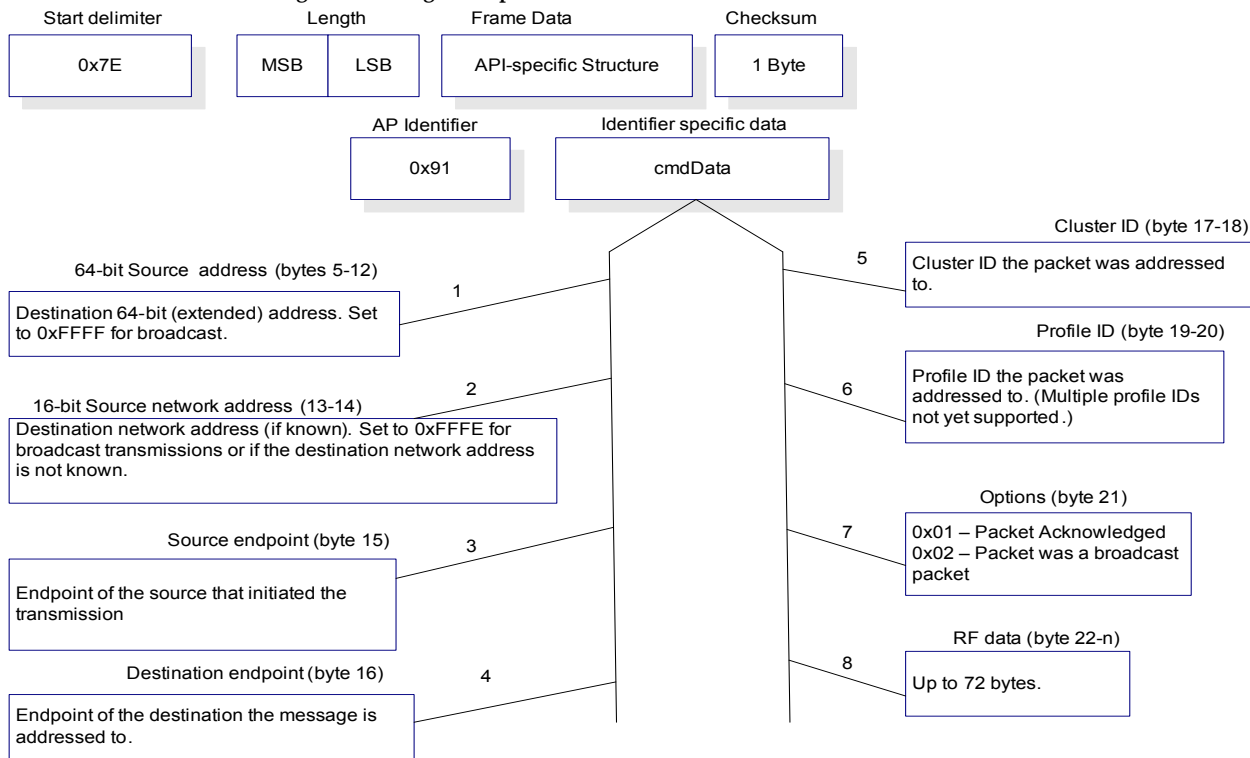

XBee Sensor Read Indicator

API Identifier Value: 0x94

When the module receives a sensor sample, it is sent out the UART using this message type (when AO=0).

Figure 7-18. XBee Sensor Read Indicator (0x94)

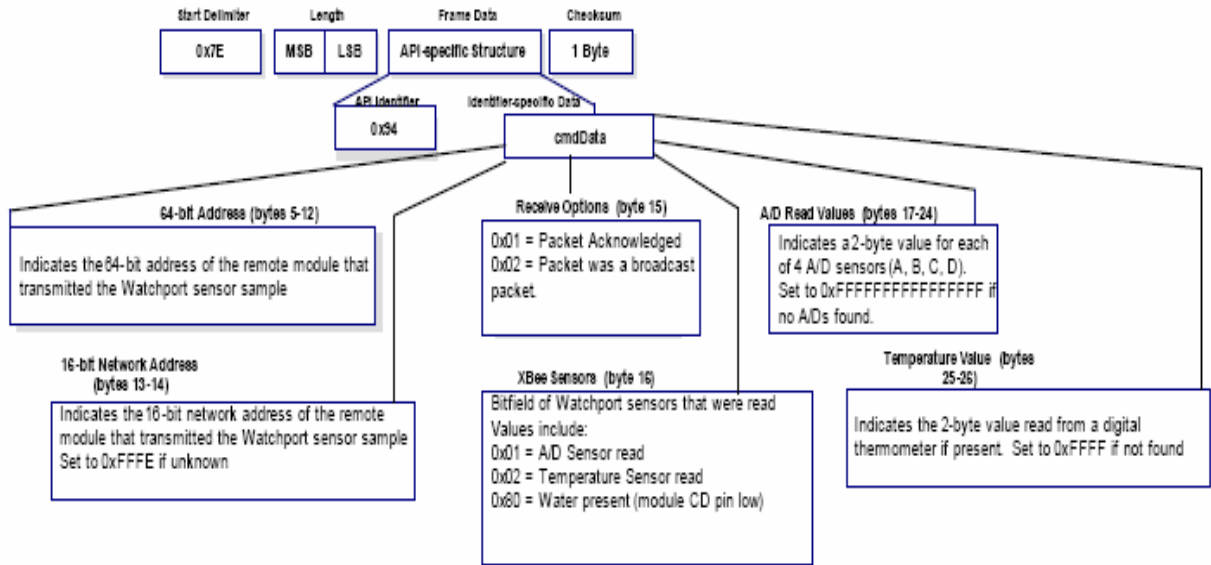

Node Identification Indicator

API Identifier Value: 0x95

This frame is received on the coordinator when a module transmits a node identification message to identify itself to the coordinator (when AO=0). The data portion of this frame is similar to a Node Discovery response frame (see ND command).

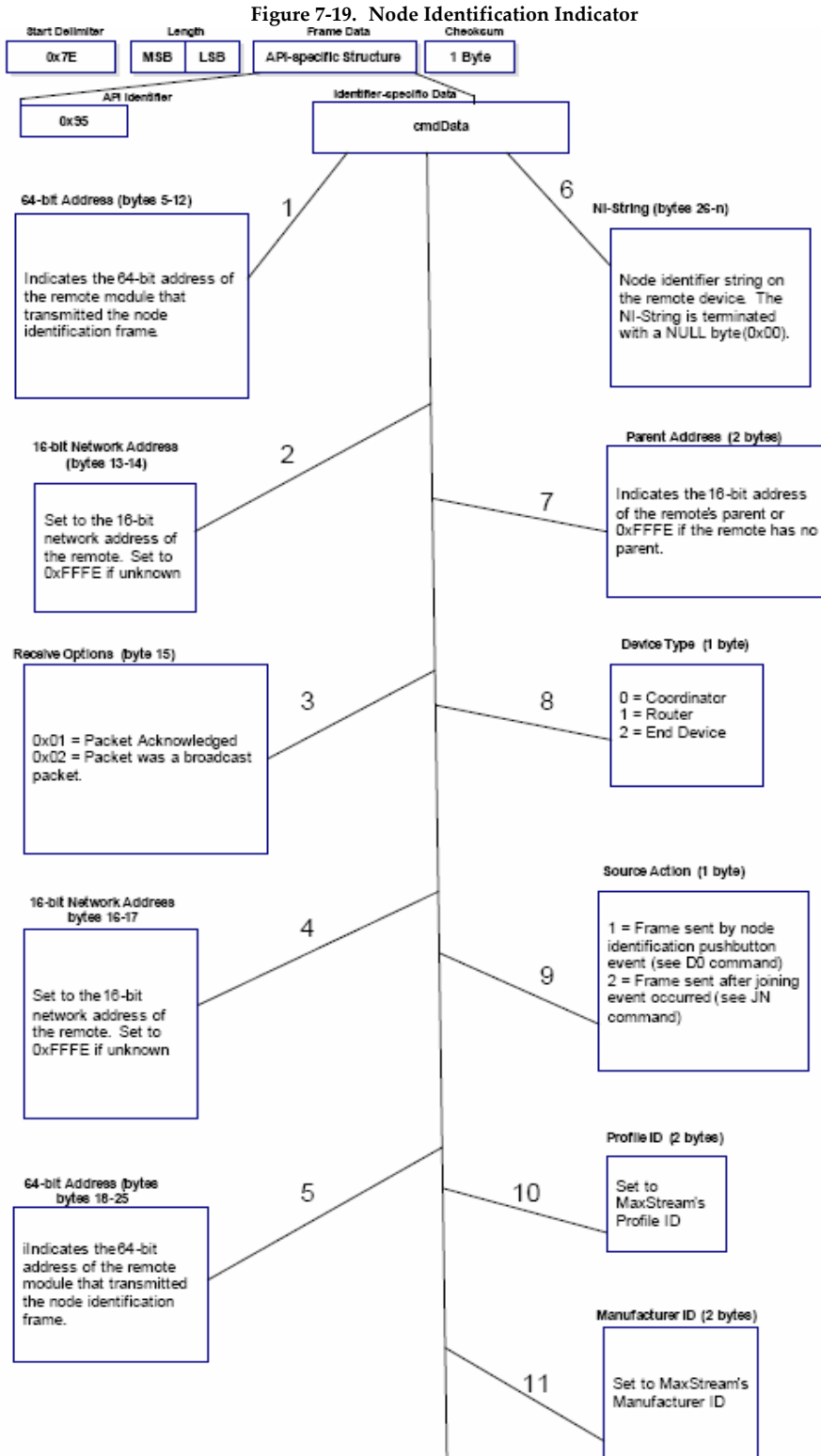

8. Examples

8.0.1. Starting an XBee Network

Start the coordinator

1. Determine the operating channels list using the SC (Scan Channels) command and the PAN ID to operate using the ID (PAN ID) command. The default SD (Scan Duration) parameter value should suffice. If these values are changed from the defaults, they should be written to non-volatile memory using the WR (Write) command.
2. The Associate LED, if enabled using the D5 (DIO5 Configuration) parameter, will start blinking 1x per second once the coordinator has started.
If API is enabled (AP parameter > 0): The API Modem Status "Coordinator Started" is sent out the UART.
3. The AI (Association Indication) parameter will be 0 signifying a successful startup.
4. The MY (16-bit Source address) attribute is 0 (the 16-bit network address of a ZigBee coordinator).
5. After startup, the coordinator will allow joining based on its NJ (Node Join Time) value.
6. It is recommended that the coordinator be configured with an NI-String identifier. This NI-String identifier should be written to non-volatile memory using the WR (Write) command to be preserved through power-loss.

Adding a Child (router)

1. Determine the operating channel list (SC) and the desired PAN ID to join (ID) (0xFFFF - join any Pan). The default SD parameter should suffice. If these values are changed from the defaults, they should be written to non-volatile memory using the WR (Write) command.
2. The router, on power-up, will attempt to locate a parent to join according to its SC and ID parameters.
3. Once the router has joined a parent, the Associate LED, if enabled (D5), will start blinking 2x per second. The ID and CH parameters will reflect the operating PAN ID and Channel. The MY parameter will reflect the 16-bit network address of the router.
If API is enabled (AP parameter > 0): The API Modem Status "Joined" is sent out the UART.
4. If the router is not joining as expected, the AI (Association Indication) parameter can be read to determine the cause of failure.
Verify the PAN contains a coordinator or nearby joined router that has matching Channel (SC, CH) and PAN ID (ID) settings and is allowing nodes to join to it (NJ parameter).
5. Once the router has joined a PAN, the router will allow joining based on the NJ parameter.
6. It is recommended that the router be configured with a unique NI-String identifier. This NI-String identifier should be written to non-volatile memory using the WR (Write) command to be preserved through power-loss.

Transmit Data (AT Firmware)

1. Start a coordinator (refer to instructions above).
2. Add one or more Child router(s) to the coordinator (refer to instructions above).
3. Once the coordinator has started, all routers and End Devices should join to a parent and their Associate LED should blink 2x per second.
4. If any nodes have not joined, read the AI command to determine why.
5. Issue the ATND command on the coordinator to get a list of all nodes on the network.
6. Use the 'Terminal' tab of the X-CTU Software to send serial data between nodes. The data should be transmitted from the source to the destination node as specified by the DH & DL parameters.
7. (Optional) Change the Destination address on any node to one of the 64-bit addresses discovered using the ND command in step 5 (DH, DL Commands, or in the 'ZigBee Transmit Request' API Frame). Then repeat step 6 to transmit data.

8.0.2. AT Command Programming Examples

Refer to the 'X-CTU' section of the Development Guide [Appendix B] for more information regarding the X-CTU configuration software.

Setup

The programming examples in this section require the installation of Digi's X-CTU Software and a serial connection to a PC. (Digi stocks RS-232 and USB boards to facilitate interfacing with a PC.)

1. Install Digi's X-CTU Software to a PC by double-clicking the "setup_X-CTU.exe" file.
2. Mount the RF module to an interface board, then connect the module assembly to a PC.
3. Launch the X-CTU Software and select the 'PC Settings' tab. Verify the baud and parity settings of the Com Port match those of the RF module.

NOTE: Failure to enter AT Command Mode is most commonly due to baud rate mismatch. Ensure the 'Baud' setting on the 'PC Settings' tab matches the interface data rate of the RF module. By default, the BD parameter = 3 (which corresponds to 9600 bps).

Sample Configuration: Modify RF Module Destination Address

Example: Utilize the X-CTU "Terminal" tab to change the RF module's DL (Destination Address Low) parameter and save the new address to non-volatile memory.

After establishing a serial connection between the RF module and a PC [refer to the 'Setup' section above], select the "Terminal" tab of the X-CTU Software and enter the following command lines ('CR' stands for carriage return):

Method 1 (One line per command)

Send AT Command	System Response
+++	OK <CR> (Enter into Command Mode)
ATDL <Enter>	{current value} <CR> (Read Destination Address Low)
ATDL1A0D <Enter>	OK <CR> (Modify Destination Address Low)
ATWR <Enter>	OK <CR> (Write to non-volatile memory)
ATCN <Enter>	OK <CR> (Exit Command Mode)

Method 2 (Multiple commands on one line)

Send AT Command	System Response
+++	OK <CR> (Enter into Command Mode)
ATDL <Enter>	{current value} <CR> (Read Destination Address Low)
ATDL1A0D,WR,CN <Enter>	OK<CR> OK<CR> OK<CR>

Sample Configuration: Restore RF Module Defaults

Example: Utilize the X-CTU "Modem Configuration" tab to restore default parameter values.

After establishing a connection between the module and a PC [refer to the 'Setup' section above], select the "Modem Configuration" tab of the X-CTU Software.

1. Select the 'Read' button.
2. Select the 'Restore' button.

8.0.3. API Programming Examples

API Configuration Using the X-CTU

The programming examples in this section require the installation of Digi's X-CTU software and a serial connection to a PC. See "Setup" example in the AT Command Programming Examples in Section 8.0.2.

1. Launch the X-CTU Software and select the 'PC Settings' tab. Verify the baud and parity settings of the Com Port match those of the RF module.
2. To communicate with a module that has API firmware, check the "Enable API" box.
3. If escaping is enabled (AP=2, non-default setting), select the "Use escape characters" box to enable escaping.
4. Select the 'Modem Configuration' tab.
5. The 'Read', 'Write', and 'Restore' buttons can be used to read module parameters, write new settings, or restore defaults.

Constructing API Frames

Example: Create an API AT command frame to configure an XBee to allow joining (set NJ to 0xFF). The frame should look like:

```
0x7E 0x00 0x05 0x08 0x01 0x4E 0x4A 0xFF 5F
```

Where 0x0005 = length

0x08 = AT Command API frame type

0x01 = Frame ID (set to non-zero value)

0x4E4A = AT Command ('NJ')

0xFF = value to set command to

0x5F = Checksum

The checksum is calculated as $[0xFF - (0x08 + 0x01 + 0x4E + 0x4A + 0xFF)]$

Example: Send a transmission to a module with destination address 0x0013A200 40014011, payload "TxData1B". If escaping is disabled, (AP=1), the frame should look like:

```
0x7E 0x00 0x16 0x10 0x01 0x00 0x13 0xA2 0x00 0x40 0x0A 0x01 0x27 0xFF
0xFE 0x00 0x00 0x54 0x78 0x44 0x61 0x74 0x61 0x30 0x41 0x13
```

Where 0x16 = length (22 bytes excluding checksum)

0x10 = ZigBee Transmit Request API frame type

0x01 = Frame ID (set to non-zero value)

0x0013A200400A0127 = 64-bit Destination Address

0xFFFFE = 16-bit Destination Address

0x00 = Broadcast radius

0x00 = Options

0x5478446174613041 = Data payload ("TxData0A")

0x64 = Checksum

If escaping is enabled (AP=2), the frame should look like:

```
0x7E 0x00 0x16 0x10 0x01 0x00 0x7D 0x33 0xA2 0x00 0x40 0x0A 0x01 0x27
0xFF 0xFE 0x00 0x00 0x54 0x78 0x44 0x61 0x74 0x61 0x30 0x41 0x7D 0x33
```

The checksum is calculated (on all non-escaped bytes) as $[0xFF - (\text{sum of all bytes from API frame type through data payload})]$.

Example: Send a transmission to the coordinator without specifying the coordinator's 64-bit address. The API transmit request frame should look like:

```
0x7E 0x00 0x16 0x10 0x01 0x00 0x00 0x00 0x00 0x00 0x00 0x00 0x00 0xFF 0xFE
0x00 0x00 0x54 0x78 032 0x43 0x6F 0x6F 0x72 0x64 0xFC
```

Where 0x16 = length (22 bytes excluding checksum)

0x10 = ZigBee Transmit Request API frame type

0x01 = Frame ID (set to non-zero value)

0x0000000000000000 = Coordinator's address (can be replaced with coordinator's actual 64-bit address if known)

0xFFFFE = 16-bit Destination Address

0x00 = Broadcast radius

0x00 = Options

0x547832436F6F7264 = Data payload ("Tx2Coord")

0xFC = Checksum

9. Manufacturing Support

9.1. Interoperability with other EM250 Devices

The XBee module can interoperate with other EM250-based devices. The following should be considered when communicating between a Digi XBee module and another EM250-based device.

The XBee firmware inserts 8 bytes at the beginning of the data payload that represent the 64-bit address of the source module. Custom devices that transmit to an XBee or receive data from an XBee should make provisions to manage these 8 address bytes in the payload. Data packets destined for an XBee module should include the source address of the sending device with the most significant byte copied first.

9.2. Customizing XBee Default Parameters

Once module parameters are determined, Digi can manufacture modules with specific customer-defined configurations. These custom configurations can lock in a firmware version or set command values when the modules are manufactured, eliminating the need for customers to adjust module parameters on arrival. Contact Digi to create a custom configuration.

9.3. XBee Series 2 Custom Bootloader

XBee Series 2 modules use a modified version of Ember's boot loader. This bootloader version supports a custom entry mechanism that uses module pins DIN (pin 3), $\overline{\text{DTR}}$ / SLEEP_RQ (pin 9), and $\overline{\text{RTS}}$ (pin 16). To invoke the boot loader, do the following:

1. Set $\overline{\text{DTR}}$ / SLEEP_RQ low (TTL 0V) and RTS high.
2. Send a serial break to the DIN pin and power cycle or reset the module.
3. When the module powers up, $\overline{\text{DTR}}$ / SLEEP_RQ and DIN should be low (TTL 0V) and RTS should be high.
4. Terminate the serial break and send a carriage return at 115200bps to the module.
5. If successful, the module will send the Ember boot loader menu out the DOUT pin at 115200bps.
6. Commands can be sent to the boot loader at 115200bps.

9.4. Programming XBee Series 2 Modules

Firmware on the XBee Series 2 modules can be upgraded using the Digi x-CTU program to interface with the DIN and DOUT serial lines, or with an InSight programmer device via InSight header.

9.5. XBee EM250 Pin Mappings

The following table shows how the GPIO pins on the EM250 map to pins on the XBee Series 2 module:

Table 9-011.

XBee Series 2 Module Pin Number	EM250 GPIO	XBee Series 2 Module Pin Number	EM250 GPIO
1	-	11	13
2	9	12	12
3	10	13	3
4	8	14	-
5	-	15	0

Table 9-011.

XBee Series 2 Module Pin Number	EM250 GPIO	XBee Series 2 Module Pin Number	EM250 GPIO
6	15	16	11
7	16	17	7
8	-	18	6
9	14	19	5
10	-	20	4

Appendix A: Definitions

Definitions

Table A-01. Terms and Definitions

ZigBee Node Types	
Coordinator	<p>A node that has the unique function of forming a network. The coordinator is responsible for establishing the operating channel and PAN ID for an entire network. Once established, the coordinator can form a network by allowing routers and end devices to join to it. Once the network is formed, the coordinator functions like a router (it can participate in routing packets and be a source or destination for data packets).</p> <ul style="list-style-type: none"> -- One coordinator per PAN -- Establishes/Organizes PAN -- Can route data packets to/from other nodes -- Can be a data packet source and destination -- Mains-powered <p>Refer to the XBee Series 2 coordinator section for more information.</p>
Router	<p>A node that creates/maintains network information and uses this information to determine the best route for a data packet. A router must join a network before it can allow other routers and end devices to join to it.</p> <p>A router can participate in routing packets and is intended to be a mains-powered node.</p> <ul style="list-style-type: none"> -- Several routers can operate in one PAN -- Can route data packets to/from other nodes -- Can be a data packet source and destination -- Mains-powered <p>Refer to the XBee Series 2 router section for more information.</p>
End device	<p>End devices must always interact with their parent to receive or transmit data. (See 'joining definition.) They are intended to sleep periodically and therefore have no routing capacity.</p> <p>An end device can be a source or destination for data packets but cannot route packets. End devices can be battery-powered and offer low-power operation.</p> <ul style="list-style-type: none"> -- Several end devices can operate in one PAN -- Can be a data packet source and destination -- All messages are relayed through a coordinator or router -- Lower power modes
ZigBee Protocol	
PAN	<p>Personal Area Network - A data communication network that includes a coordinator and one or more routers/end devices.</p>

Table A-01. Terms and Definitions

Joining	The process of a node becoming part of a ZigBee PAN. A node becomes part of a network by joining to a coordinator or a router (that has previously joined to the network). During the process of joining, the node that allowed joining (the parent) assigns a 16-bit address to the joining node (the child).
Network Address	The 16-bit address assigned to a node after it has joined to another node. The coordinator always has a network address of 0.
Operating Channel	The frequency selected for data communications between nodes. The operating channel is selected by the coordinator on power-up.
Energy Scan	A scan of RF channels that detects the amount of energy present on the selected channels. The coordinator uses the energy scan to determine the operating channel.
Route Request	Broadcast transmission sent by a coordinator or router throughout the network in attempt to establish a route to a destination node.
Route Reply	Unicast transmission sent back to the originator of the route request. It is initiated by a node when it receives a route request packet and its address matches the Destination Address in the route request packet.
Route Discovery	The process of establishing a route to a destination node when one does not exist in the Routing Table. It is based on the AODV (Ad-hoc On-demand Distance Vector routing) protocol.
ZigBee Stack	ZigBee is a published specification set of high-level communication protocols for use with small, low-power modules. The ZigBee stack provides a layer of network functionality on top of the 802.15.4 specification. For example, the mesh and routing capabilities available to ZigBee solutions are absent in the 802.15.4 protocol.

Appendix B: Agency Certifications

United States FCC

The XBee Series 2 RF Module complies with Part 15 of the FCC rules and regulations. Compliance with the labeling requirements, FCC notices and antenna usage guidelines is required.

To fulfill FCC Certification, the OEM must comply with the following regulations:

1. The system integrator must ensure that the text on the external label provided with this device is placed on the outside of the final product. [Figure A-01]
2. XBee Series 2 RF Module may only be used with antennas that have been tested and approved for use with this module [refer to the antenna tables in this section].

OEM Labeling Requirements



WARNING: The Original Equipment Manufacturer (OEM) must ensure that FCC labeling requirements are met. This includes a clearly visible label on the outside of the final product enclosure that displays the contents shown in the figure below.

Required FCC Label for OEM products containing the XBee Series 2 RF Module

Contains FCC ID: OUR-XBEE2*

The enclosed device complies with Part 15 of the FCC Rules. Operation is subject to the following two conditions: (i.) this device may not cause harmful interference and (ii.) this device must accept any interference received, including interference that may cause undesired operation.

Required FCC Label for OEM products containing the XBee Series 2 PRO RF Module

Contains FCC ID:MCQ-XBEEPRO2*

The enclosed device complies with Part 15 of the FCC Rules. Operation is subject to the following two conditions: (i.) this device may not cause harmful interference and (ii.) this device must accept any interference received, including interference that may cause undesired operation.

FCC Notices

IMPORTANT: The XBee Series 2 and XBEE Series 2 PRO RF Module have been certified by the FCC for use with other products without any further certification (as per FCC section 2.1091). Modifications not expressly approved by Digi could void the user's authority to operate the equipment.

IMPORTANT: OEMs must test final product to comply with unintentional radiators (FCC section 15.107 & 15.109) before declaring compliance of their final product to Part 15 of the FCC Rules.

IMPORTANT: The RF module has been certified for remote and base radio applications. If the module will be used for portable applications, the device must undergo SAR testing.

This equipment has been tested and found to comply with the limits for a Class B digital device, pursuant to Part 15 of the FCC Rules. These limits are designed to provide reasonable protection against harmful interference in a residential installation. This equipment generates, uses and can radiate radio frequency energy and, if not installed and used in accordance with the instructions, may cause harmful interference to radio communications. However, there is no guarantee that interference will not occur in a particular installation.

If this equipment does cause harmful interference to radio or television reception, which can be determined by turning the equipment off and on, the user is encouraged to try to correct the interference by one or more of the following measures: Re-orient or relocate the receiving antenna, Increase the separation between the equipment and receiver, Connect equipment and receiver to outlets on different circuits, or Consult the dealer or an experienced radio/TV technician for help.

FCC-Approved Antennas (2.4 GHz)

The XBee Series 2 and XBee Series 2 PRO RF Module can be installed utilizing antennas and cables constructed with standard connectors (Type-N, SMA, TNC, etc.) if the installation is performed professionally and according to FCC guidelines. For installations not performed by a professional, non-standard connectors (RPSMA, RPTNC, etc.) must be used.

The modules are FCC approved for fixed base station and mobile applications on channels 0x0B-0x1A for Xbee Series2 and on channels 0x0B - 0x18 for Xbee Series2 Pro. If the antenna is mounted at least 20cm (8 in.) from nearby persons, the application is considered a mobile application. Antennas not listed in the table must be tested to comply with FCC Section 15.203 (Unique Antenna Connectors) and Section 15.247 (Emissions).

XBee Series 2 RF Modules: XBee Series 2 RF Modules have been tested and approved for use with all the antennas listed in the tables below. (Cable-loss IS required when using gain antennas as shown below.)

Table A-01. Antennas approved for use with the XBee/XBee-PRO OEM RF Modules (all 2.4 GHz)

YAGI CLASS ANTENNAS				
Part Number	Type (Description)	Gain	Application*	Min. Separation Required
A24-HABMM-PSI	Dipole (Half-wave bulkhead mount articulated MMCX w/ pigtail)	2.1 dBi	Fixed/Mobile*	20 cm
A24-HBMM-PSI	Dipole (Half-wave bulkhead mount MMCX w/ pigtail)	2.1 dBi	Fixed/Mobile*	20 cm
A24-HABSM	Dipole (Articulated RPSMA)	2.1 dBi	Fixed/Mobile*	20 cm
A24-QBMM-PSI	Monopole (Quarter-wave bulkhead mount MMCX w/ pigtail)	1.9 dBi	Fixed/Mobile*	20 cm
A24-QABMM-PSI	Monopole (Quarter-wave bulkhead mount articulated MMCX w/pigtail)	1.9 dBi	Fixed/Mobile*	20 cm
A24-QI	Monopole (Integrated whip)	1.9 dBi	Fixed/Mobile*	20 cm
A24-C1	Surface Mount	-1.5 dBi	Fixed/Mobile*	20 cm
A24-Y4NF	Yagi (4-element)	6.0 dBi	Fixed*	2 m
A24-Y6NF	Yagi (6-element)	8.8 dBi	Fixed*	2 m
A24-Y7NF	Yagi (7-element)	9.0 dBi	Fixed*	2 m
A24-Y9NF	Yagi (9-element)	10.0 dBi	Fixed*	2 m
A24-Y10NF	Yagi (10-element)	11.0 dBi	Fixed*	2 m
A24-Y12NF	Yagi (12-element)	12.0 dBi	Fixed*	2 m
A24-Y13NF	Yagi (13-element)	12.0 dBi	Fixed*	2 m
A24-Y15NF	Yagi (15-element)	12.5 dBi	Fixed*	2 m
A24-Y16NF	Yagi (16-element)	13.5 dBi	Fixed*	2 m
A24-Y16RM	Yagi (16-element, RPSMA connector)	13.5 dBi	Fixed*	2 m
A24-Y18NF	Yagi (18-element)	15.0 dBi	Fixed*	2 m
A24-F2NF	Omni-directional (Fiberglass base station)	2.1 dBi	Fixed/Mobile*	20 cm
A24-F3NF	Omni-directional (Fiberglass base station)	3.0 dBi	Fixed/Mobile*	20 cm
A24-F5NF	Omni-directional (Fiberglass base station)	5.0 dBi	Fixed/Mobile*	20 cm
A24-F8NF	Omni-directional (Fiberglass base station)	8.0 dBi	Fixed*	2 m
A24-F9NF	Omni-directional (Fiberglass base station)	9.5 dBi	Fixed*	2 m
A24-F10NF	Omni-directional (Fiberglass base station)	10.0 dBi	Fixed*	2 m
A24-F12NF	Omni-directional (Fiberglass base station)	12.0 dBi	Fixed*	2 m
A24-F15NF	Omni-directional (Fiberglass base station)	15.0 dBi	Fixed*	2 m
A24-W7NF	Omni-directional (Base station)	7.2 dBi	Fixed*	2 m
A24-M7NF	Omni-directional (Mag-mount base station)	7.2 dBi	Fixed*	2 m
A24-P8SF	Flat Panel	8.5 dBi	Fixed*	2 m
A24-P8NF	Flat Panel	8.5 dBi	Fixed*	2 m
A24-P13NF	Flat Panel	3.0 dBi	Fixed*	12 m
A24-P14NF	Flat Panel	14.0 dBi	Fixed*	2 m

YAGI CLASS ANTENNAS					
Part Number	Type (Description)	Gain	Application*	Min. Separation Required	
A24-P15NF	Flat Panel	15.0 dBi	Fixed*	2 m	
A24-P16NF	Flat Panel	16.0 dBi	Fixed*	2 m	
A24-P19NF	Flat Panel	19.0 dBi	Fixed*	2 m	

Table A-02. antennas approved for use with the XBee Series 2 RF Modules

YAGI CLASS ANTENNAS					
Part Number	Type (Description)	Gain	Application*	Min. Separation Required	Cable-loss
A24-Y6NF	Yagi (6-element)	8.8 dBi	Fixed	2 m	7.8dB
A24-Y7NF	Yagi (7-element)	9.0 dBi	Fixed	2 m	8 dB
A24-Y9NF	Yagi (9-element)	10.0 dBi	Fixed	2 m	9 dB
A24-Y10NF	Yagi (10-element)	11.0 dBi	Fixed	2 m	10 dB
A24-Y12NF	Yagi (12-element)	12.0 dBi	Fixed	2 m	11 dB
A24-Y13NF	Yagi (13-element)	12.0 dBi	Fixed	2 m	11 dB
A24-Y15NF	Yagi (15-element)	12.5 dBi	Fixed	2 m	11.5 dB
A24-Y16NF	Yagi (16-element)	13.5 dBi	Fixed	2 m	12.5 dB
A24-Y16RM	Yagi (16-element, RPSMA connector)	13.5 dBi	Fixed	2 m	12.5 dB
A24-Y18NF	Yagi (18-element)	15.0 dBi	Fixed	2 m	14 dB
OMNI-DIRECTIONAL ANTENNAS					
Part Number	Type (Description)	Gain	Application*	Min. Separation Required	Cable-loss
A24-C1	Surface Mount integral chip	1.5 dBi	Fixed/Mobile	20 cm	-
A24-F2NF	Omni-directional (Fiberglass base station)	2.1 dBi	Fixed/Mobile	20 cm	-
A24-F3NF	Omni-directional (Fiberglass base station)	3.0 dBi	Fixed/Mobile	20 cm	.3 dB
A24-F5NF	Omni-directional (Fiberglass base station)	5.0 dBi	Fixed/Mobile	20 cm	2.3 dB
A24-F8NF	Omni-directional (Fiberglass base station)	8.0 dBi	Fixed	2 m	5.3 dB
A24-F9NF	Omni-directional (Fiberglass base station)	9.5 dBi	Fixed	2 m	6.8 dB
A24-F10NF	Omni-directional (Fiberglass base station)	10.0 dBi	Fixed	2 m	7.3 dB
A24-F12NF	Omni-directional (Fiberglass base station)	12.0 dBi	Fixed	2 m	9.3dB
A24-F15NF	Omni-directional (Fiberglass base station)	15.0 dBi	Fixed	2 m	12.3dB
A24-W7NF	Omni-directional (Base station)	7.2 dBi	Fixed	2 m	4.5 dB
A24-M7NF	Omni-directional (Mag-mount base station)	7.2 dBi	Fixed	2 m	4.5 dB
PANEL CLASS ANTENNAS					
Part Number	Type (Description)	Gain	Application*	Min. Separation Required	Cable-loss
A24-P8SF	Flat Panel	8.5 dBi	Fixed	2 m	8.2 dB
A24-P8NF	Flat Panel	8.5 dBi	Fixed	2 m	82 dB
A24-P13NF	Flat Panel	13.0 dBi	Fixed	2 m	12.7 dB
A24-P14NF	Flat Panel	14.0 dBi	Fixed	2 m	13.7 dB
A24-P15NF	Flat Panel	15.0 dBi	Fixed	2 m	14.7 dB
A24-P16NF	Flat Panel	16.0 dBi	Fixed	2 m	15.7 dB
A24-P19NF	Flat Panel	19.0 dBi	Fixed	2m	18.7 dB

Table A-03. antennas approved for use with the XBee Series 2 PRO RF Modules

YAGI CLASS ANTENNAS					
Part Number	Type (Description)	Gain	Application*	Min. Separation Required	Cable-loss
A24-Y6NF	Yagi (6-element)	8.8 dBi	Fixed	2 m	N/A
A24-Y7NF	Yagi (7-element)	9.0 dBi	Fixed	2 m	N/A
A24-Y9NF	Yagi (9-element)	10.0 dBi	Fixed	2 m	N/A
A24-Y10NF	Yagi (10-element)	11.0 dBi	Fixed	2 m	N/A
A24-Y12NF	Yagi (12-element)	12.0 dBi	Fixed	2 m	N/A
A24-Y13NF	Yagi (13-element)	12.0 dBi	Fixed	2 m	N/A
A24-Y15NF	Yagi (15-element)	12.5 dBi	Fixed	2 m	N/A
A24-Y16NF	Yagi (16-element)	13.5 dBi	Fixed	2 m	N/A

YAGI CLASS ANTENNAS					
Part Number	Type (Description)	Gain	Application*	Min. Separation Required	Cable-loss
A24-Y16RM	Yagi (16-element, RPSMA connector)	13.5 dBi	Fixed	2 m	N/A
A24-Y18NF	Yagi (18-element)	15.0 dBi	Fixed	2 m	N/A
OMNI-DIRECTIONAL ANTENNAS					
Part Number	Type (Description)	Gain	Application*	Min. Separation Required	Cable-loss
A24-C1	Surface Mount integral chip	1.5 dBi	Fixed/Mobile	20 cm	N/A
A24-F2NF	Omni-directional (Fiberglass base station)	2.1 dBi	Fixed/Mobile	20 cm	N/A
A24-F3NF	Omni-directional (Fiberglass base station)	3.0 dBi	Fixed/Mobile	20 cm	N/A
A24-F5NF	Omni-directional (Fiberglass base station)	5.0 dBi	Fixed/Mobile	20 cm	N/A
A24-F8NF	Omni-directional (Fiberglass base station)	8.0 dBi	Fixed	2 m	N/A
A24-F9NF	Omni-directional (Fiberglass base station)	9.5 dBi	Fixed	2 m	N/A
A24-F10NF	Omni-directional (Fiberglass base station)	10.0 dBi	Fixed	2 m	N/A
A24-F12NF	Omni-directional (Fiberglass base station)	12.0 dBi	Fixed	2 m	N/A
A24-F15NF	Omni-directional (Fiberglass base station)	15.0 dBi	Fixed	2 m	N/A
A24-W7NF	Omni-directional (Base station)	7.2 dBi	Fixed	2 m	N/A
A24-M7NF	Omni-directional (Mag-mount base station)	7.2 dBi	Fixed	2 m	N/A
PANEL CLASS ANTENNAS					
Part Number	Type (Description)	Gain	Application*	Min. Separation Required	Cable-loss
A24-P8SF	Flat Panel	8.5 dBi	Fixed	2 m	N/A
A24-P8NF	Flat Panel	8.5 dBi	Fixed	2 m	N/A
A24-P13NF	Flat Panel	13.0 dBi	Fixed	2 m	N/A
A24-P14NF	Flat Panel	14.0 dBi	Fixed	2 m	N/A
A24-P15NF	Flat Panel	15.0 dBi	Fixed	2 m	N/A
A24-P16NF	Flat Panel	16.0 dBi	Fixed	2 m	N/A
A24-P19NF	Flat Panel	19.0 dBi	Fixed	2m	1.5 dB

* If using the RF module in a portable application (For example - If the module is used in a handheld device and the antenna is less than 20cm from the human body when the device is in operation): The integrator is responsible for passing additional SAR (Specific Absorption Rate) testing based on FCC rules 2.1091 and FCC Guidelines for Human Exposure to Radio Frequency Electromagnetic Fields, OET Bulletin and Supplement C. The testing results will be submitted to the FCC for approval prior to selling the integrated unit. The required SAR testing measures emissions from the module and how they affect the person.

RF Exposure



WARNING: To satisfy FCC RF exposure requirements for mobile transmitting devices, a separation distance of 20 cm or more should be maintained between the antenna of this device and persons during device operation. To ensure compliance, operations at closer than this distance are not recommended. The antenna used for this transmitter must not be co-located in conjunction with any other antenna or transmitter.

The preceding statement must be included as a CAUTION statement in OEM product manuals in order to alert users of FCC RF Exposure compliance.

Europe (ETSI)

The XBee Series 2 RF Module has been certified for use in several European countries. For a complete list, refer to www.digi.com

If the XBee Series 2 RF Modules are incorporated into a product, the manufacturer must ensure compliance of the final product to the European harmonized EMC and low-voltage/safety standards. A Declaration of Conformity must be issued for each of these standards and kept on file as described in Annex II of the R&TTE Directive.

Furthermore, the manufacturer must maintain a copy of the XBee Series 2 user manual documentation and ensure the final product does not exceed the specified power ratings, antenna specifications, and/or installation requirements as specified in the user manual. If any of these specifications are exceeded in the final product, a submission must be made to a notified body for compliance testing to all required standards.

OEM Labeling Requirements

The 'CE' marking must be affixed to a visible location on the OEM product.

Figure B-01. CE Labeling Requirements

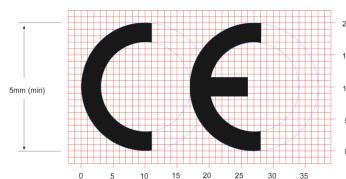

The CE mark shall consist of the initials "CE" taking the following form:

- If the CE marking is reduced or enlarged, the proportions given in the above graduated drawing must be respected.
- The CE marking must have a height of at least 5mm except where this is not possible on account of the nature of the apparatus.
- The CE marking must be affixed visibly, legibly, and indelibly.

Restrictions

Power Output: The power output of the XBee Series 2 RF Module must not exceed 10 dBm. The power level is set using the PL command and the PL parameter must equal "0" (10 dBm).

France: France imposes restrictions on the 2.4 GHz band. Go to www.art-telecom.fr or contact MaxStream for more information.

Norway: Norway prohibits operation near Ny-Alesund in Svalbard. More information can be found at the Norway Posts and Telecommunications site (www.npt.no).

Declarations of Conformity

Digi has issued Declarations of Conformity for the XBee Series 2 RF Modules concerning emissions, EMC and safety. Files are located in the 'documentation' folder of the Digi CD.

Important Note

Digi does not list the entire set of standards that must be met for each country. Digi customers assume full responsibility for learning and meeting the required guidelines for each country in their distribution market. For more information relating to European compliance of an OEM product incorporating the XBee Series 2 RF Module, contact Digi, or refer to the following web sites:

CEPT ERC 70-03E - Technical Requirements, European restrictions and general requirements: Available at www.ero.dk/.

R&TTE Directive - Equipment requirements, placement on market: Available at www.ero.dk/.

Approved Antennas

When integrating high-gain antennas, European regulations stipulate EIRP power maximums. Use the following guidelines to determine which antennas to design into an application.

XBee Series 2 OEM Module

The following antennas types have been tested and approved for use with the XBee Series 2 Module:

Antenna Type: Yagi

RF module was tested and approved with 15 dBi antenna gain with 1 dB cable-loss (EIRP Maximum of 14 dBm). Any Yagi type antenna with 14 dBi gain or less can be used with no cable-loss.

Antenna Type: Omni-Directional

RF module was tested and approved with 15 dBi antenna gain with 1 dB cable-loss (EIRP Maximum of 14 dBm). Any Omni-Directional type antenna with 14 dBi gain or less can be used with no cable-loss.

Antenna Type: Flat Panel

RF module was tested and approved with 19 dBi antenna gain with 4.8 dB cable-loss (EIRP Maximum of 14.2 dBm). Any Flat Panel type antenna with 14.2 dBi gain or less can be used with no cable-loss.

XBee Series 2 RF Module

The following antennas have been tested and approved for use with the embedded XBee Series 2 RF Module:

- Dipole (2.1 dBi, Omni-directional, Articulated RPSMA, Digi part number A24-HABSM)
- Chip Antenna (-1.5 dBi)
- Attached Monopole Whip (1.5 dBi)

XBee Series 2 Pro RF Module

The following antennas have been tested and approved for use with the embedded XBee Series 2 Pro RF Module:

- Dipole (2.1 dBi, Omni-directional, Articulated RPSMA, Digi part number A24-HABSM)
- Chip Antenna (-1.5 dBi)
- Attached Monopole Whip (1.5 dBi).

Canada (IC)

Labeling Requirements

Labeling requirements for Industry Canada are similar to those of the FCC. A clearly visible label on the outside of the final product enclosure must display the following text:

Contains Model XBee Series 2 Radio, IC: 4214A-XBEE2

The integrator is responsible for its product to comply with IC ICES-003 & FCC Part 15, Sub. B - Unintentional Radiators. ICES-003 is the same as FCC Part 15 Sub. B and Industry Canada accepts FCC test report or CISPR 22 test report for compliance with ICES-003.

If it contains an XBee Series 2 Pro OEM Module, the clearly visible label on the outside of the final product enclosure must display the following text:

Contains Model XBee Series 2 Pro Radio, IC: 1846A-XBEEPRO2

The integrator is responsible for its product to comply with IC ICES-003 & FCC Part 15, Sub. B - Unintentional Radiators. ICES-003 is the same as FCC Part 15 Sub. B and Industry Canada accepts FCC test report or CISPR 22 test report for compliance with ICES-003.

Appendix C: Migrating from the 802.15.4 Protocol

The following are some of the differences in the ZigBee firmware assuming familiarity with the 802.15.4 application:

- ZigBee Command Set
- Address Assignment
- API / AT Firmware Versions

Also, refer to the "Getting Started" section for more information.

ZigBee Command Set

Modified Commands

- CH - Read Only command that displays the operating channel that was selected from SC.
- MY - Read Only command that displays the assigned 16-bit network address of the device.
- AI - ZigBee definitions added to this command. See documentation.
- A1, A2 and CE commands are not supported.

New Commands

- NJ (Node Join Time) - This value determines how long a Coordinator or Router will allow other devices to join to it. This command is supported on Coordinators & Routers only.
- MP (16-bit Parent Network Address). This value represents the 16-bit parent network address of the module.
- BH (Broadcast Hops). This value sets the maximum number of hops for each broadcast data transmission. Setting this to 0 will use the maximum number of hops.

API / AT Firmware Versions

The 802.15.4 firmware supports the AP command for setting the module into No API (AP=0), API without escaping (AP=1), or API with escaping (AP=2) modes. The first digit in the 802.15.4 firmware versions is a '1'.

The ZigBee firmware comes in different versions to support the API interface (AP 1, 2 modes) or the AT command set (AP 0 mode). The first digit in the ZigBee firmware versions is an '8'.

The following is a list of firmware versions:

- 1.0xx - Coordinator, AT Command support (Transparent Mode)
- 1.1xx - Coordinator, API support (AP 1, 2)
- 1.2xx - Router, End Device, AT Command support (Transparent Mode)
- 1.3xx - Router, End Device, API support (AP 1, 2)

Appendix D: Development Guide

XBee Series 2 Development Kits

The XBee Series 2 Professional Development Kit includes the hardware and software needed to rapidly create long range wireless data links between nodes (XBee Series 2 Starter Kits that contain fewer modules and accessories are also available).

Table D-01. Items Included in the Development Kit

Item	Qty.	Description	Part #
XBee Series 2 Module	5	(1) OEM RF Module, AT Coordinator with wire antenna	XB24-BWIt-002
		(1) OEM RF Module, AT Router/End Device with wire antenna	XB24-BWIT-004
		(1) OEM RF Module, AT Router/End Device with U.FL antenna	XB24-BUIT-004
		(1) OEM RF Module, AT Router/End Device with chip antenna	XB24-BCIT-004
		(1) OEM RF Module, AT Router/End Device with SMA antenna	XB24-BSIT-004
RS-232 Development Board	4	Board for interfacing between modules and RS-232 nodes (Converts signal levels, displays diagnostic info, & more)	XBIB-R
USB Development Board	1	Board for interfacing between modules & USB nodes (Converts signal levels, displays diagnostic info, & more)	XBIB-U
RS-232 Cable (6', straight-through)	1	Cable for connecting RS-232 interface board with DTE nodes (nodes that have a male serial DB-9 port - such as most PCs)	JD2D3-CDS-6F
USB Cable (6')	1	Cable for connecting USB interface board to USB nodes	JU1U2-CSB-6F
Serial Loopback Adapter	1	[Red] Adapter for configuring the module assembly (module + RS-232 interface board) to function as a repeater for range testing	JD2D3-CDL-A
NULL Modem Adapter (male-to-male)	1	[Black] Adapter for connecting the module assembly (module + RS-232 interface board) to other DCE (female DB-9) nodes	JD2D2-CDN-A
NULL Modem Adapter (female-to-female)	1	[Gray] Adapter for connecting serial nodes. It allows users to bypass the radios to verify serial cabling is functioning properly.	JD3D3-CDN-A
Power Adapter (9VDC, 1 A)	1	Adapter for powering the RS-232 development board	JP5P2-9V11-6F
Battery Clip (9V)	1	Clip for remotely powering the RS-232 board w/ a 9V battery	JP2P3-C2C-4I
RPSMA Antenna	2	RPSMA half-wave dipole antenna (2.4 GHz, 2.1 dB)	A24-HASM-450
RF Cable Assembly	2	Adapter for connecting RPSMA antenna to U.FL connector	JF1R6-CR3-4I
CD	1	Documentation and Software	MD0030
Quick Start Guide	1	Step-by-step instruction on how to create wireless links & test range capabilities of the modules	MD0026

Interfacing Options

The development kit includes RS-232 and USB interface boards. The boards provide a connection to PC ports and therefore give access to the RF module registries. Parameters stored in the registry allow OEMs and integrators to customize the modules to suite the needs of their data radio systems.

The following sections illustrate how to use the interface boards for development purposes. The MaxStream Interface board provides means for connecting the module to any node that has an available RS-232 or USB connector. Since the module requires signals to enter at TTL voltages, one of the main functions of the interface board is to convert signals between TTL levels and RS-232 and USB levels.

Note: In the following sections, an OEM RF Module mounted to an interface board will be referred to as a "Module Assembly".

RS-232 Development Board

External Interface

Figure B-01. Front View

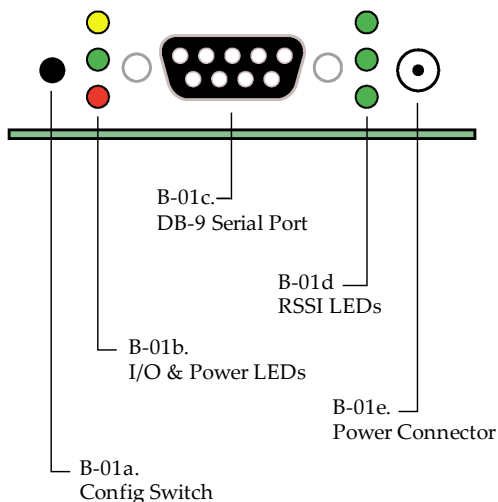

B-01a. Reset Switch

The Reset Switch is used to reset (re-boot) the RF module. This switch only applies when using the configuration tabs of Digi's X-CTU Software.

B-01b. I/O & Power LEDs

LEDs indicate RF module activity as follows:

- Yellow (top LED) = Serial Data Out (to host)
- Green (middle) = Serial Data In (from host)
- Red (bottom) = Power/Association Indicator (Refer to the D5 (DIO5 Configuration) parameter)

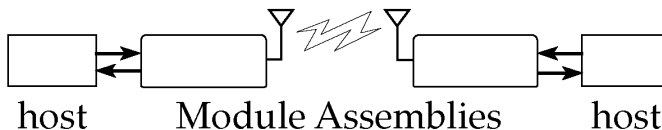

B-01c. Serial Port

Standard female DB-9 (RS-232) connector.

B-01d. RSSI LEDs

RSSI LEDs indicate the amount of fade margin present in an active wireless link. Fade margin is defined as the difference between the incoming signal strength and the module's receiver sensitivity.

- 3 LEDs ON = Very Strong Signal (> 30 dB fade margin)
- 2 LEDs ON = Strong Signal (> 20 dB fade margin)
- 1 LED ON = Moderate Signal (> 10 dB fade margin)
- 0 LED ON = Weak Signal (< 10 dB fade margin)

B-01e. Power Connector

5-14 VDC power connector

B-02a. DIP Switch

DIP Switch functions are not supported in this release. Future downloadable firmware versions will support DIP Switch configurations.

Figure B-02. Back View

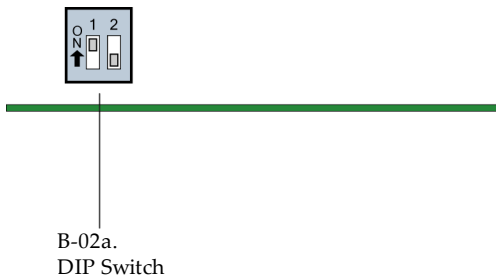

RS-232 Pin Signals

Figure B-03. Pins used on the female RS-232 (DB-9) Serial Connector

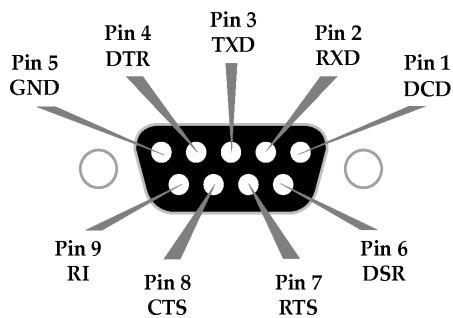

Table D-02. Pin Assignments and Implementations

DB-9 Pin	RS-232 Name	Description	Implementation*
1	DCD	Data-Carrier-Detect	Connected to DSR (pin6)
2	RXD	Receive Data	Serial data exiting the module assembly (to host)
3	TXD	Transmit Data	Serial data entering into the module assembly (from host)
4	DTR	Data-Terminal-Ready	Can enable Power-Down on the module assembly
5	GND	Ground Signal	Ground
6	DSR	Data-Set-Ready	Connected to DCD (pin1)
7	$\overline{\text{RTS}}$ / CMD	Request-to-Send / Command Mode	Provides $\overline{\text{RTS}}$ flow control or enables Command Mode
8	$\overline{\text{CTS}}$	Clear-to-Send	Provides $\overline{\text{CTS}}$ flow control
9	RI	Ring Indicator	Optional power input that is connected internally to the positive lead of the front power connector

* Functions listed in the implementation column may not be available at the time of release.

Wiring Diagrams

Figure B-04. DTE node (RS-232, male DB-9 connector) wired to a DCE Module Assembly (female DB-9)

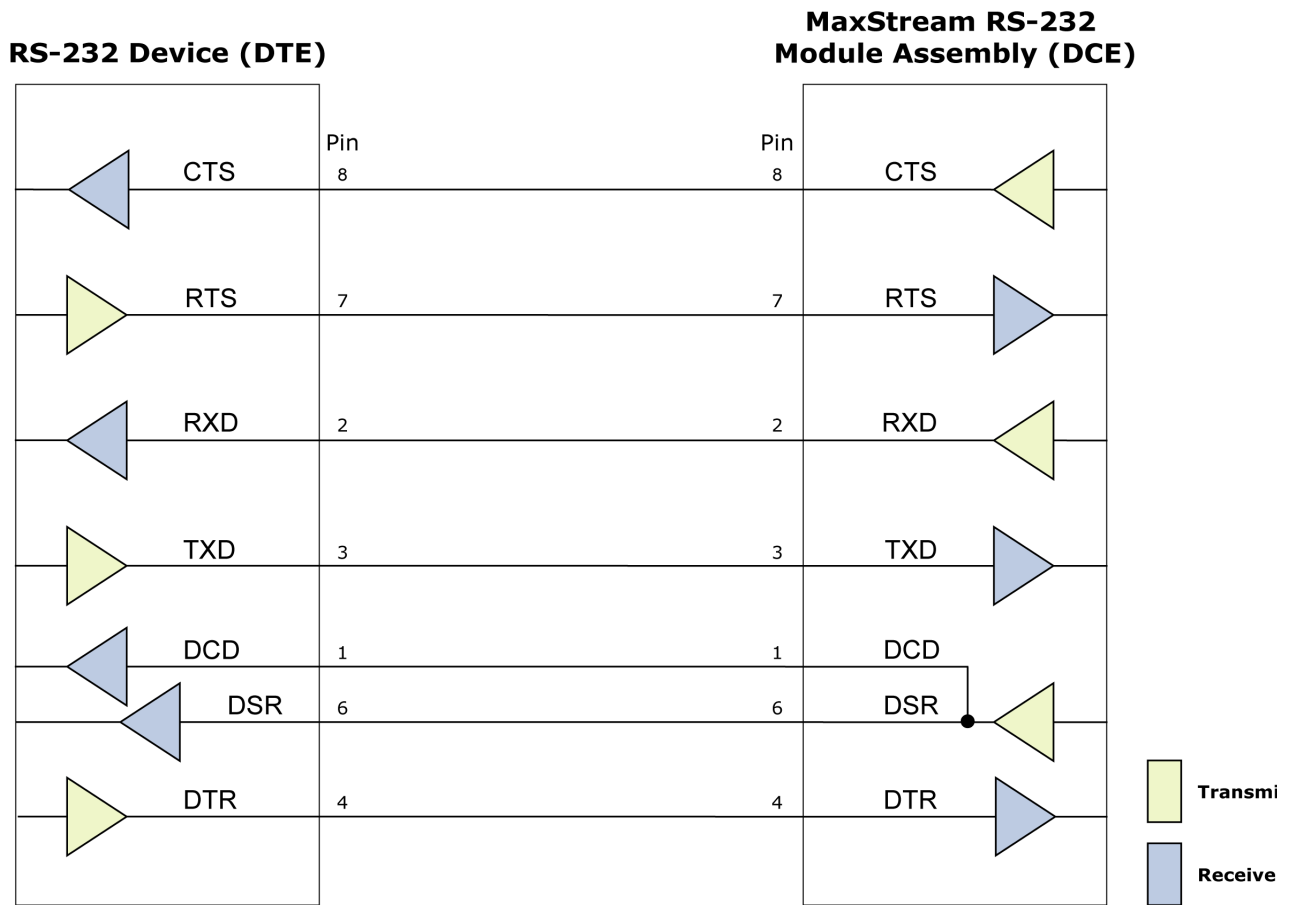
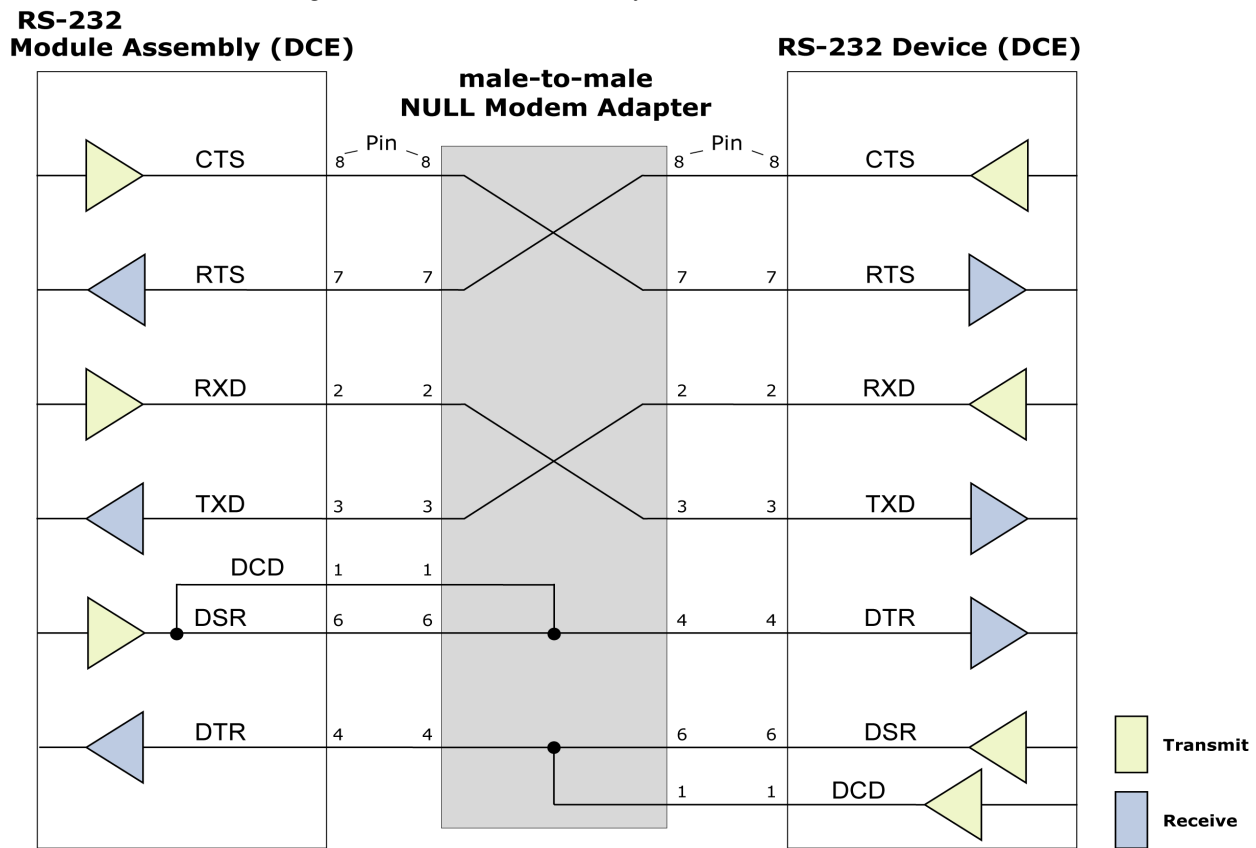
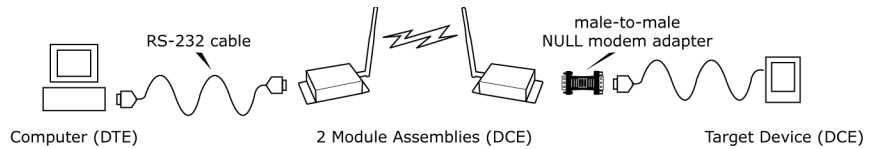

Figure B-05. DCE Module Assembly (female DB-9 connector) wired to a DCE node (RS-232, male DB-9)



Sample Wireless Connection: DTE <--> DCE <--> DCE <--> DCE

Figure B-06. Typical wireless link between DTE and DCE nodes



Adapters

The development kit includes several adapters that support the following functions:

- Performing Range Tests
- Testing Cables
- Connecting to other RS-232 DCE and DTE nodes
- Connecting to terminal blocks or RJ-45 (for RS-485/422 nodes)

NULL Modem Adapter (male-to-male)

Part Number: JD2D2-CDN-A (Black, DB-9 M-M) The male-to-male NULL modem adapter is used to connect two DCE nodes. A DCE node connects with a straight-through cable to the male serial port of a computer (DTE).

Figure B-07. Male NULL modem adapter and pinouts

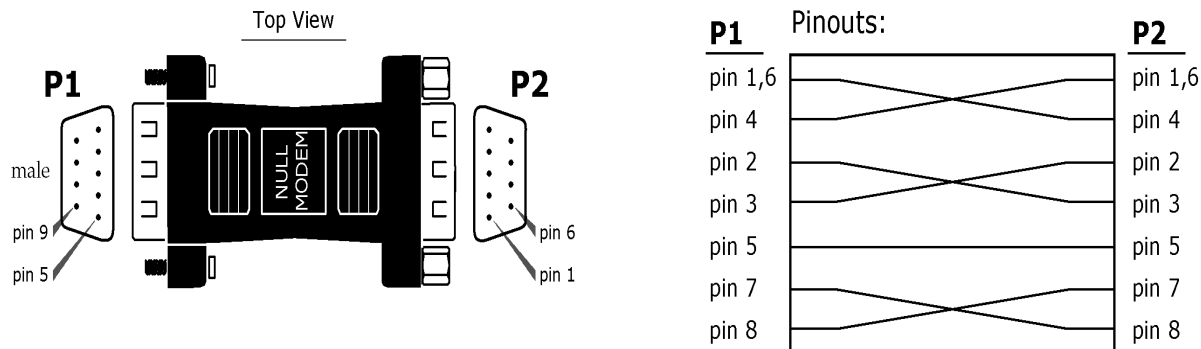
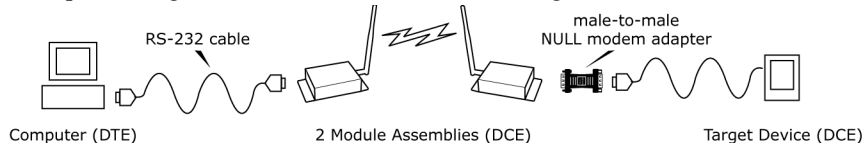

Figure B-08. Example of a Digi Radio Modem (DCE node) connecting to another DCE node



NULL Modem Adapter (female-to-female)

Part Number: JD3D3-CDN-A (Gray, DB-9 F-F) The female-to-female NULL modem adapter is used to verify serial cabling is functioning properly. To test cables, insert the female-to-female NULL modem adapter in place of a pair of module assemblies (RS-232 interface board + XTend Module) and test the connection without the modules in the connection.

Figure B-09. Female NULL modem adapter and pinouts

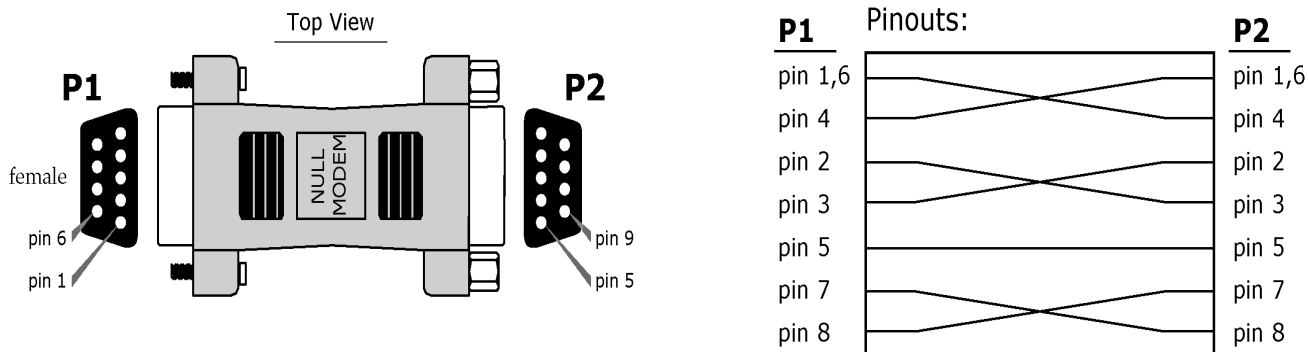

Serial Loopback Adapter

Part Number: JD2D3-CDL-A (Red, DB-9 M-F) The serial loopback adapter is used for range testing. During a range test, the serial loopback adapter configures the module to function as a repeater by looping serial data back into the radio for retransmission.

Figure D-01. Serial loopback adapter and pinouts

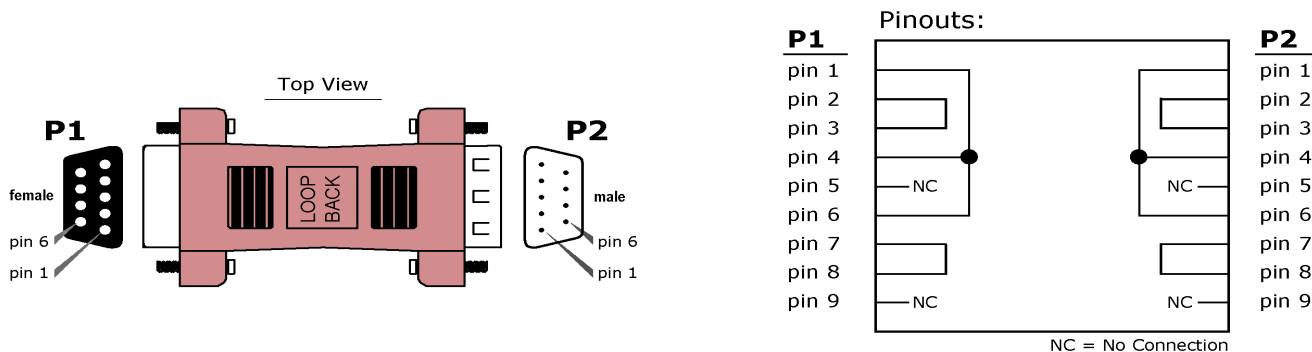

USB Development Board

External Interface

B-11a. I/O & Power LEDs

Figure D-02. Front View

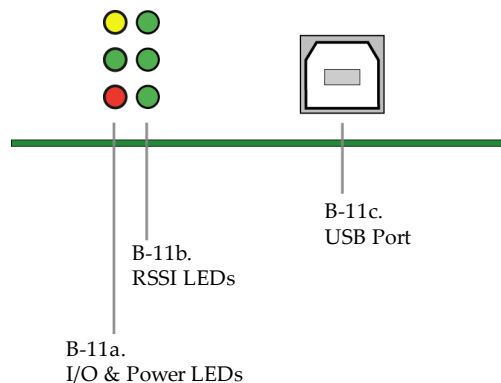

LEDs indicate RF module activity as follows:

- Yellow (top LED) = Serial Data Out (to host)
- Green (middle) = Serial Data In (from host)
- Red (bottom) = Power/Association Indicator (Refer to the D5 (DIO5 Configuration) parameter)



B-11b. RSSI LEDs

RSSI LEDs indicate the amount of fade margin present in an active wireless link. Fade margin is defined as the difference between the incoming signal strength and the module's receiver sensitivity.

- 3 LEDs ON = Very Strong Signal (> 30 dB fade margin)
- 2 LEDs ON = Strong Signal (> 20 dB fade margin)
- 1 LED ON = Moderate Signal (> 10 dB fade margin)
- 0 LED ON = Weak Signal (< 10 dB fade margin)

B-11c. USB Port

Standard Type-B OEM connector is used to communicate with OEM host and power the RF module.

B-12a. DIP Switch

Figure D-03. Back View

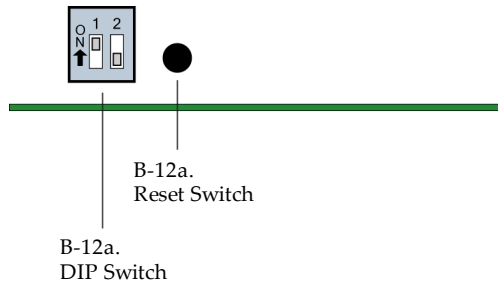

DIP Switch functions are not supported in this release. Future downloadable firmware versions will support the DIP Switch configurations.

B-12b. Reset Switch

The Reset Switch is used to reset (re-boot) the RF module.

USB Pin Signals

Table D-03. USB signals and their implantations on the XBee Series 2/XBee Series 2 PRO RF Module

Pin	Name	Description	Implementation
1	VBUS	Power	Power the RF module
2	D-	Transmitted & Received Data	Transmit data to and from the RF module
3	D+	Transmitted & Received Data	Transmit data to and from the RF module
4	GND	Ground Signal	Ground

X-CTU Software

X-CTU is a Digi-provided software program used to interface with and configure Digi RF Modules. The software application is organized into the following four tabs:

- PC Settings tab - Setup PC serial ports for interfacing with an RF module
- Range Test tab - Test the RF module's range and monitor packets sent and received
- Terminal tab - Set and read RF module parameters using AT Commands
- Modem Configuration tab - Set and read RF module parameters

Figure D-04. X-CTU User Interface (PC Settings, Range Test, Terminal and Modem Configuration tabs)

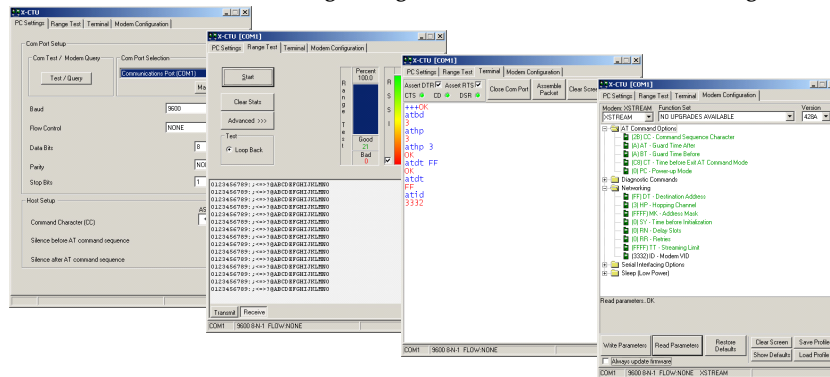

NOTE: PC Setting values are visible at the bottom of the Range Test, Terminal and Modem Configuration tabs. A shortcut for editing PC Setting values is available by clicking on any of the values.

Install

Double-click the "setup_X-CTU.exe" file and follow prompts of the installation screens. Setup

To use the X-CTU software, a module assembly (An RF module mounted to an interface Board) must be connected to a serial port of a PC. The interface data rate and parity settings of the serial port ("PC Settings" tab) must match those of the module (BD (Baud Rate) and NB (Parity) parameters).

Serial Communications Software

A terminal program is built into the X-CTU Software. Other terminal programs such as "HyperTerminal" can also be used. When issuing AT Commands through a terminal program interface, use the following syntax:

Figure D-05. Syntax for sending AT Commands

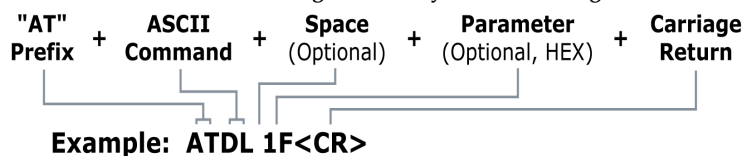

NOTE: To read a parameter value stored in a register, leave the parameter field blank.

The example above issues the DL (Destination Address Low) command to change destination address of the module to "0x1F". To save the new value to the module's non-volatile memory, issue WR (Write) command after modifying parameters.

Appendix E: Additional Information

1-Year Warranty

XBee Series 2 RF Modules from Digi, Inc. (the "Product") are warranted against defects in materials and workmanship under normal use, for a period of 1-year from the date of purchase. In the event of a product failure due to materials or workmanship, Digi will repair or replace the defective product. For warranty service, return the defective product to MaxStream, shipping prepaid, for prompt repair or replacement.

The foregoing sets forth the full extent of MaxStream's warranties regarding the Product. Repair or replacement at MaxStream's option is the exclusive remedy. THIS WARRANTY IS GIVEN IN LIEU OF ALL OTHER WARRANTIES, EXPRESS OR IMPLIED, AND DIGI SPECIFICALLY DISCLAIMS ALL WARRANTIES OF MERCHANTABILITY OR FITNESS FOR A PARTICULAR PURPOSE. IN NO EVENT SHALL DIGI, ITS SUPPLIERS OR LICENSORS BE LIABLE FOR DAMAGES IN EXCESS OF THE PURCHASE PRICE OF THE PRODUCT, FOR ANY LOSS OF USE, LOSS OF TIME, INCONVENIENCE, COMMERCIAL LOSS, LOST PROFITS OR SAVINGS, OR OTHER INCIDENTAL, SPECIAL OR CONSEQUENTIAL DAMAGES ARISING OUT OF THE USE OR INABILITY TO USE THE PRODUCT, TO THE FULL EXTENT SUCH MAY BE DISCLAIMED BY LAW. SOME STATES DO NOT ALLOW THE EXCLUSION OR LIMITATION OF INCIDENTAL OR CONSEQUENTIAL DAMAGES. THEREFORE, THE FOREGOING EXCLUSIONS MAY NOT APPLY IN ALL CASES. This warranty provides specific legal rights. Other rights which vary from state to state may also apply.

Ordering Information

Figure E-01. Divisions of the XBee Series 2 RF Module Part Numbers"

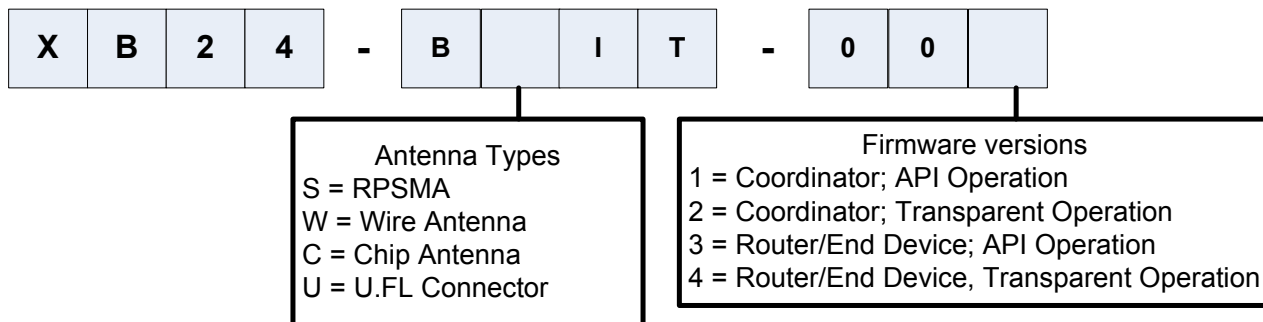

Contact Digi

Free and unlimited technical support is included with every Digi Radio Modem sold. For the best in wireless data solutions and support, please use the following resources:

Technical Support:	Phone.	(866) 765-9885 toll-free U.S.A. & Canada (801) 765-9885 Worldwide
	Live Chat.	www.digi.com
	E-Mail.	support@digi.com

Digi's office hours are 8:00 am - 5:00 pm [U.S. Central Standard Time]